

High Definition (HD) Satellite Receiver DTV1080

Operating Guide and Warranty



Introduction

Important Overview

Setup and Connections

Remote Control

Initial Setup

Basic Operation

Advanced Program Guide™

Customization

EZ Help





WARNING
RISK OF ELECTRIC SHOCK
DO NOT OPEN



WARNING:

TO REDUCE THE RISK OF ELECTRONIC SHOCK DO NOT REMOVE COVER (OR BACK).
NO USER SERVICEABLE PARTS INSIDE.
REFER TO QUALIFIED SERVICE PERSONNEL.



THE LIGHTNING FLASH WITH ARROWHEAD SYMBOL, WITHIN AN EQUILATERAL TRIANGLE, IS INTENDED TO ALERT THE USER TO THE PRESENCE OF UNINSULATED "DANGEROUS VOLTAGE" WITHIN THE PRODUCT'S ENCLOSURE THAT MAY BE OF SUFFICIENT MAGNITUDE TO CONSTITUTE A RISK OF ELECTRIC SHOCK TO PERSONS.



THE EXCLAMATION POINT WITHIN AN EQUILATERAL TRIANGLE IS INTENDED TO ALERT THE USER TO THE PRESENCE OF IMPORTANT OPERATING AND MAINTENANCE (SERVICING) INSTRUCTIONS IN THE LITERATURE ACCOMPANYING THE APPLIANCE.

WARNING

TO PREVENT FIRE OR SHOCK HAZARDS, DO NOT EXPOSE THIS PRODUCT TO RAIN OR MOISTURE.

NOTE TO CABLE/TV/SATELLITE DISH INSTALLER:

This reminder is provided to call the cable TV system/satellite dish installer's attention to Article 820-40 of the National Electric Code (U.S.A). The code provides guidelines for proper grounding and, in particular, specifies that the cable ground shall be connected to the grounding system of the building, as close to the point of the cable entry as practical.

POWER CORD POLARIZATION

Caution: TO PREVENT ELECTRONIC SHOCK, MATCH WIDE BLADE OF PLUG TO WIDE SLOT, FULLY INSERT.

Attention: Pour éviter les chocs électriques, introduire la lame la plus large de la fiche dans la born.

REGULATORY INFORMATION

This equipment, trade name Zenith, model number, DTV1080, has been tested and found to comply with the limits for a Class B digital device, pursuant to Part 15 of the FCC Rules. These limits are designed to provide reasonable protection against harmful interference when the equipment is operated in a residential installation. This equipment generates, uses and can radiate radio frequency energy and, if not installed and used in accordance with the instruction manual, may cause harmful interference to radio communications.

However, there is no guarantee that interference will not occur in a particular installation. If this equipment does cause harmful interference to radio or television reception, which can be determined by turning the equipment off and on, the user is encouraged to try to correct the interference by one or more of the following measures:

- Reorient or relocate the receiving antenna.
- Increase the separation between the equipment and receiver.
- Connect the equipment into an outlet on a circuit different from that to which the receiver is connected.
- Consult the dealer or an experienced radio/TV technician for help.

REGULATORY INFORMATION: FCC Part 68

- This product complies with Part 68 of the FCC rules. On the back of this product is a label that contains, among other information, the FCC registration number and Ringer Equivalent Number (REN) for this product. If requested, this information must be provided to the telephone company.
- The REN is used to determine the quantity of devices that may be connected to the telephone line. Excessive RENs on the telephone line may result in the devices not ringing in response to an incoming call. Typically, the sum of the RENs should not exceed five (5). To be certain of the number of devices that may be connected to the line (as determined by the total RENs) contact the local telephone company.
- If this product causes harm to the telephone network, the telephone company will notify you in advance that temporary discontinuance of service may be required. But if advance notice isn't practical, the telephone company will notify the customer as soon as possible. Also, you will be advised of your right to file a complaint with the FCC if you believe it is necessary.
- The telephone company may make changes to its facilities, equipment, operations or procedures that could affect the operation of the product. If this happens, the telephone company will provide advance notice so you can make the necessary modifications to maintain uninterrupted service.
- Connection to party line service is subject to state tariffs. (Contact the state public utility commission, public service commission, or corporate commission for information.)
- If trouble is experienced with this product, for repair or warranty information, please contact Zenith Electronics Corporation. If the product is causing harm to the telephone network, the telephone company may request that you disconnect the product until the problem is resolved.
- An FCC compliant telephone cord and modular plug is provided with this equipment. This equipment is designed to be connected to the telephone network or premises wiring using a compatible modular jack which is Part 68 compliant. See installation instructions for details.

COMPLIANCE: The responsible party for this product's compliance is:

Zenith Electronics Corporation, 2000 Millbrook Drive, Lincolnshire, IL, 60069, USA • Phone: 1-847-391-7000

CAUTION

DO NOT ATTEMPT TO MODIFY THIS PRODUCT IN ANY WAY WITHOUT WRITTEN AUTHORIZATION FROM ZENITH ELECTRONICS CORPORATION. UNAUTHORIZED MODIFICATION COULD VOID THE USER'S AUTHORITY TO OPERATE THIS PRODUCT.

THIS EQUIPMENT IS INTENDED TO RECEIVE AND DECODE SIGNALS TRANSMITTED ACCORDING TO ATSC DIGITAL TELEVISION STANDARD A/53, DIRECTV® SPECIFICATION AND IS INTENDED TO BE USED WITH AN APPROPRIATE ANTENNA, DISH AND DISPLAY DEVICE THAT YOU MUST PROVIDE.

Dolby Digital®

Manufactured under license from Dolby Laboratories.

"Dolby" and the double-D symbol are trademarks of Dolby Laboratories.

Confidential Unpublished Works. ©1992-1997 Dolby Laboratories, Inc. All rights reserved.

IMPORTANT SAFETY INSTRUCTIONS

1. Read Instructions

Read all of the safety and operating instructions before operating the product.

2. Retain Instructions

Keep all safety and operating instructions for future reference.

3. Heed Warnings

Follow warnings on the product and in the operating guide.

4. Follow Instructions

Follow all operating and use instructions.

5. Cleaning

Unplug this product from the wall power outlet before cleaning. Do not use liquid cleaners or aerosol cleaners. Use a damp cloth for cleaning.

6. Attachments

Do not use attachments not recommended by product manufacturer as they may cause hazards.

7. Water and Moisture

Do not use this product near water - for example, near a bathtub, wash bowl, sink, or laundry tub, in a wet basement, or near a swimming pool.

8. Accessories, Carts and Stands

Do not place this product on a slippery or tilted surface or on an unstable cart, stand, tripod, bracket, or table. The product may slide or fall, causing serious injury to a child or adult, and serious damage to the product. Use only with a cart, stand, tripod, bracket, or table recommended by the manufacturer, or sold with the product. Any mounting of the product should follow the manufacturer's instructions, and should use a mounting accessory recommended by the manufacturer.

9. Transporting Product

Move product and cart combinations with care. Quick stops, excessive force, and uneven surfaces may cause product and cart combination to overturn.

10. Ventilation

Slots and openings in the cabinet must not be blocked or covered. They are provided for ventilation, to ensure reliable operation, and to protect from overheating. Never block openings by placing the product on a bed, sofa, rug, or other similar surface. Do not place the product in a built-in installation such as a bookcase or rack unless proper ventilation is provided or manufacturer's instructions have been adhered to.

11. Power Sources

Operate product only from the type of power source indicated on marking label. If you are not sure of the type of power supply to your home, consult your product dealer or local power company. For products intended to operate from battery power or other sources, refer to the operating guide.

12. Power-Cord Polarization

This product is equipped with a polarized alternating-current line plug (a plug having one blade wider than the other). As a safety feature, this plug will fit into the power outlet only one way. If you're unable to insert the plug fully into the outlet, try reversing the plug. If the plug still fails to fit, contact an electrician to replace your obsolete outlet. Do not defeat the safety purpose of the polarized plug.

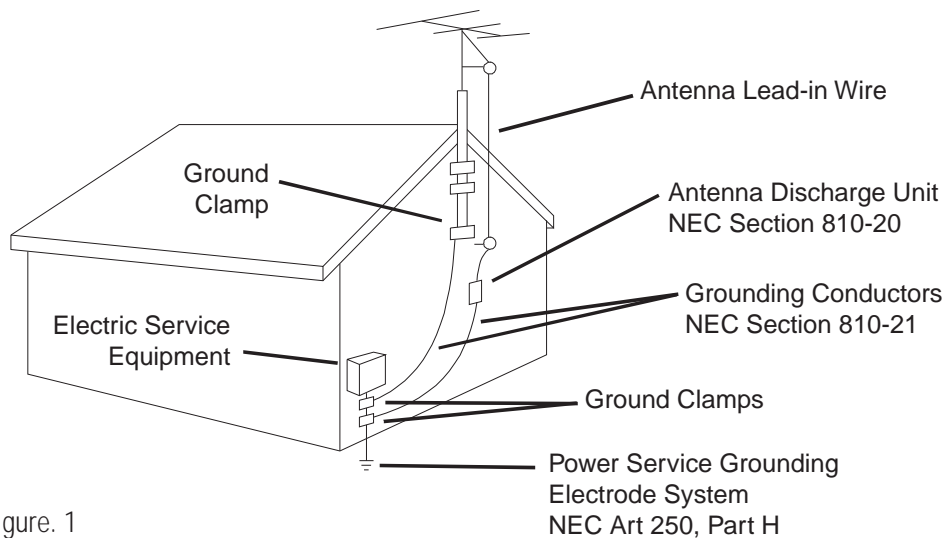

Figure. 1

13. Power-Cord Protection

Route power-supply cords so they are not likely to be walked on or pinched by items placed upon or against them, paying particular attention to cords at plugs, convenience receptacles, and the point where they exit from the product.

14. Outdoor Antenna Grounding

If an outside antenna or cable system is connected to this product, be sure the antenna or cable system is grounded so as to provide some protection against voltage surges and built-up static charges. Article 810 of the National Electrical Code (USA), ANSI/NFPA 70, provides information on grounding of the mast and supporting structure, grounding of the lead-in wire to an antenna discharge unit

connection to the grounding electrodes, and requirements for the grounding electrode. (See Figure.1 on reverse side for an example).

15. Lightning

For added protection for this product during a lightning storm, or when product is left unattended and unused for long periods of time, unplug it from the wall outlet and disconnect antenna or cable system. This will prevent damage to product due to lightning and power line surges.

IMPORTANT SAFETY INSTRUCTIONS

16. Power Lines

An outside antenna system should not be located in the vicinity of overhead power lines or other electric light or power circuits, or where it can fall into such power lines or circuits. When installing an outside antenna system, take extreme care to keep from touching such power lines or circuits, as contact with them might be fatal.

17. Overloading

Do not overload wall outlets, extension cords or integral convenience receptacles, as this can result in risk of fire or electric shock.

18. Object and Liquid Entry

Never push objects of any kind into this product through openings, as they may touch dangerous voltage points or shortout parts that could result in fire or electric shock. Never spill liquid of any kind on the product.

19. Heat

Keep product away from heat sources such as radiators, heat registers, stoves, or other products (including amplifiers) that produce heat.

20. Wall or Ceiling Mounting

The product should be mounted to a wall or ceiling only as recommended by the manufacturer. The product may slide or fall, causing serious injury to a child or adult and serious damage to the product.

21. Servicing

Do not attempt to service this product yourself, as opening or removing covers may expose you to dangerous voltage or other hazards. Refer all servicing to qualified service personnel.

22. Damage Requiring Service

Unplug this product from the wall outlet and refer servicing to qualified service personnel under these conditions:

- If the power-supply cord or plug is damaged.
- If liquid has been spilled or objects have fallen into the product.
- If the product has been exposed to rain or water.
- If the product doesn't operate normally by following the operating guide. Adjust only those controls covered by the operating guide; improper adjustment of other controls may result in damage and often requires extensive work by a qualified technician to restore the product to normal operation.
- If the product has been dropped or cabinet has been damaged.
- If the product exhibits a distinct change in performance.

23. Replacement Parts

When replacement part(s) are required, be sure service technician has used replacement part(s) specified by manufacturer or have same characteristics as original part(s).

Unauthorized substitutions may result in fire, electric shock, or other hazards.

24. Safety Check

Upon completion of any service or repairs to this product, ask service technician to perform safety checks to determine that product is in proper operating condition.

IMPORTANT INFORMATION

Due to copyright restrictions, you may not be able to view some high definition programs in high definition format using this product. If HD viewing is prohibited due to copyright restrictions, you would need to connect SD interfaces to view the program.

With this receiver "Zenith DTV1080" and the proper satellite dish antenna, you may be able to subscribe to local channels from DIRECTV in certain areas. Additional equipment may be required in some markets. Check with your retailer or visit DIRECTV.com for information on availability of local channels from DIRECTV in your area.

Programming subject to change must be physically located in the U.S to receive DIRECTV service. DIRECTV services not available outside the U.S DIRECTV programming is sold separately and independently of DIRECTV System hardware. A valid programming subscription is required to operate DIRECTV System hardware. Activate your DIRECTV programming today at 1-800-DIRECTV (1-800-347-3288)

DIRECTV, the Cyclone Design logo and Advanced Program Guide are trademarks of DIRECTV, Inc., a unit of Hughes Electronics Corp., and are used with permission.

TABLE OF CONTENTS

	Safety Warning -----	1
	Important Safety Instructions -----	2
	Important Information -----	5
	Table of Contents -----	6
1. Introduction		
	1-1. A New World of Digital Entertainment -----	8
	1-2. Main Features -----	9
2. Important Overview		
	2-1. Sending Signals -----	10
	2-2. TV Signal Formats -----	11
	2-3. Normal and Wide Format Signal -----	12
	2-4. Audio Signals -----	14
	2-5. On-Screen Display -----	16
3. Setup and Connections		
	3-1. Unpacking -----	18
	3-2. Back Panel of the Zenith HD Satellite Receiver -----	20
	3-3. General Recommendations -----	22
	3-4. Connecting to Antennas -----	23
	3-5. TV Connection -----	27
	3-6. VCR Connection -----	30
	3-7. Audio Connection -----	31
4. Remote Control		
	4-1. Using the Front Panel of the HD satellite receiver ---	33
	4-2. Using the Remote Control -----	34
	4-3. Programming the Remote Control -----	37
	4-4. Remote Control Codes for Other Components -----	38
5. Initial Setup -----		41
6. Basic Operation		
	6-1. Viewing the Channel Banner -----	42
	6-2. Channel Surfing -----	44
	6-3. Subscription to DIRECTV® Programming and ANT/CABLE- Only operation -----	45

7. Advanced Program Guide™	7-1. About the Advanced Program Guide™ -----	46
	7-2. Layout of the Advanced Program Guide™ Screen --	47
	7-3. Moving through the Advanced Program Guide™ ---	48
	7-4. Selecting a Program -----	49
	7-5. Getting More Information -----	50
	7-6. Referring to EZ Help -----	51
	7-7. Making a Remind List for Future Viewing -----	52
	7-8. Purchasing Pay Per View Programs -----	53
	7-9. Searching Programs by Category -----	54
	7-10. Searching Programs by Keyword -----	55
8. Customization	8-1. The Structure of the On-screen Menu -----	56
	8-2. The Hierarchy of the On-screen Menu -----	57
	8-3. Previewing the Remind List -----	58
	8-4. Managing Program Purchases -----	59
	8-5. Checking the Mail Box -----	61
	8-6. Initializing the System -----	62
	8-7. Managing Channels -----	66
	8-8. EZ Hook-up -----	70
	8-9. Setting the Clock -----	71
	8-10. Setting the Audio -----	73
	8-11. Choosing the Aspect Ratio -----	78
	8-12. Setting Closed Caption -----	80
	8-13. Setting Default Signal Out -----	82
	8-14. Setting the Digital TV Input -----	84
	8-15. Running EZ Demo -----	85
	8-16. Setting Locks -----	86
	8-17. Testing the System -----	92
	8-18. Upgrading Software -----	93
	8-19. Replace Card -----	94
9. EZ Help	-----	95
Reference	Product Specifications -----	97
	Troubleshooting -----	99
	Zenith Warranty -----	101

1. INTRODUCTION

1-1. A New World of Digital Entertainment

Welcome to the Zenith High Definition (HD) Satellite Receiver, an advanced digital satellite receiver that showcases a new generation of digital entertainment.

Different from conventional analog broadcasts, digital broadcasts allow you to enjoy superior quality video and audio right in your own home.

Your Zenith HD Satellite Receiver serves as a digital receiver that makes it possible to view digital programs even on your analog TV, and has a Built-in DIRECTV System that delivers a variety of programs available from DIRECTV through a satellite, if you are a DIRECTV customer.

The Advanced Program Guide™ also enables you to access and view over-the-air broadcasts and cable as well as DIRECTV® Programming.



1-2. Main Features

Ultimate Entertainment

- **A Wide Variety of Programs**

Hundreds of channels are available from DIRECTV.

- **Advanced Program Guide™**

Instant access to over three-day program listings including over-the-air (NTSC, ATSC) and satellite.

Ability to jump a day at a time.

Ability to search and tune by program title, keyword and category.

Technical Flexibility

- **Seamless Tuning**

Tune seamlessly to over-the-air, cable and satellite.

- **Multiple Output Jacks**

Multiple output jacks are provided on the back panel of the HD satellite receiver.

- **Screen Format Adaptability**

Various screen formats are available including 1080i, 720p, 480p and 480i.

- **HD Formatted On-Screen Display**

Advanced look and feel for the on-screen display menu and Advanced Program Guide™.

- **Software Upgrade**

Software upgrading from DIRECTV.

- **ANT/CABLE Only Mode**

Viewing analog/digital broadcasting through over-the-air antenna without subscribing to DIRECTV® programming.

Superior Performance

- **Crisp Picture**

High definition or resolution with a 16:9 aspect ratio.

- **Superior Sound**

Sensational sound with Dolby Digital 5.1 channels.

Fingertip Convenience

- **EZ Link**

The Zenith HD Satellite Receiver can be controlled by the Zenith TV remote control through EZ Link connection.

- **EZ Help**

Easy-to-use on-screen menus with instant spot help and brief on-screen user's guide.

- **EZ Hook-up**

The on-screen menus show connection schemes on the HD satellite receiver.

2. IMPORTANT OVERVIEW

2-1. Sending Signals

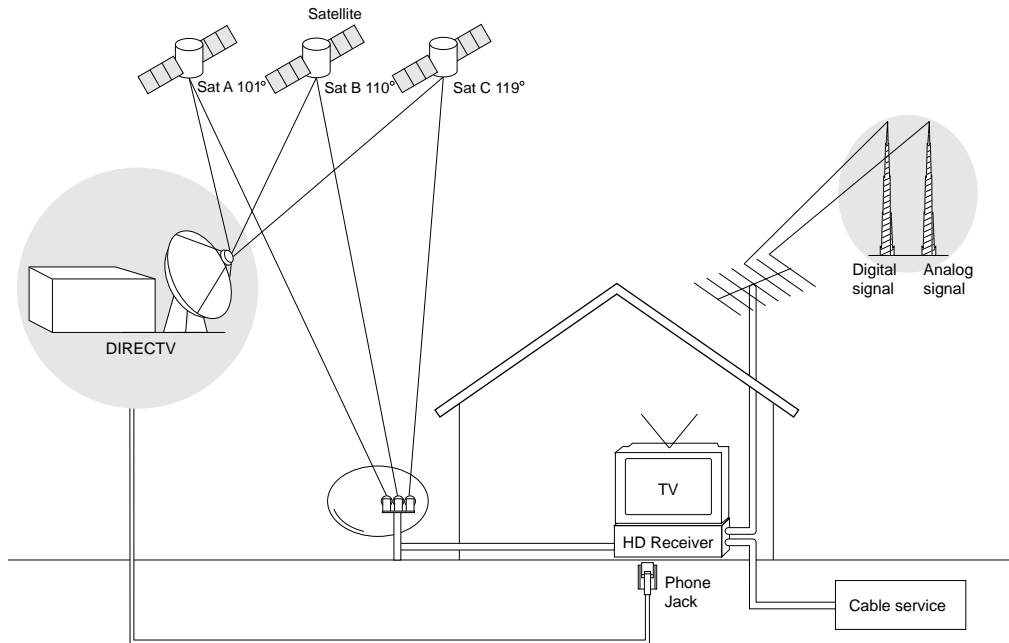

Digital broadcasting is a new way of sending programs over the airwaves with superior quality video and audio. The Zenith HD Satellite Receiver enables you to take full advantage of digital broadcasting. To fully enjoy it, you need to understand the ways the program signals are sent.

There are two types of TV signal formats; analog (often called NTSC format; National Television System Committee) and digital (ATSC format; Advanced Television System Committee). Digital formats are classified into three categories: High Definition (HD) Enhanced Definition (ED) and Standard Definition (SD) according to the resolution or digital picture quality.

There are also three ways that program signals can be received; over-the-air (NTSC, ATSC), cable, and Satellite.

2-2. TV Signal Formats

Standards Comparison Table

Signal Format	Analog (NTSC)	HD Digital (ATSC/DIRECTV®)
Total Lines	525	1125
Active Lines	480	1080
Sound	Stereo (2 ch)	Surround (5.1 ch)
Aspect Ratio	4 : 3	16 : 9
Max Resolution	720 X 480	1920 X 1080

What makes HD digital signals (including SD signals) special is that they provide a high resolution and wide format, like a movie (16:9 TV aspect ratio). On the other hand, analog signals have the standard or normal format (4:3 TV aspect ratio). Thus, you receive programs with two distinct formats. Like a wide movie screen, the HD digital signals are formatted more like the way we actually see; our field of vision is more rectangular than square. So, when we view movies in a wide screen format, the image fills more of our field of vision yielding a stronger visual impact.

HD digital program signals use smaller pixels that are closer together. In the area taken up by a single pixel of a standard NTSC signal, HD digital signals will have four and a half pixels, four times the detail. The more pixels in a given area, the better the picture.

Some NTSC televisions can display a picture 720 pixels wide by 480 pixels high, that's a total of 345,600 pixels. HD digital signals can have a resolution of 1920 x 1080, that's 2,073,600 pixels, or six times more pixels than the older resolution. Pictures will be crisper and cleaner, with more detail in every close-up and every panorama.

2. IMPORTANT OVERVIEW

2-3. Normal and Wide Format Signals

When you view a picture with a wide (16:9) aspect ratio with 480i or 480p mode of display format switch in the rear panel, the button changes the screen format in the cycle of Letterbox, Cropped, to Squeezed. When you view a picture with a normal (4:3) aspect ratio on a with 720p or 1080i mode of display format switch, the button changes the screen format in the cycle of Normal, Wide, Panorama, Zoom1, to Zoom2.

WHEN YOU SET THE DISPLAY FORMAT SWITCH TO SDTV (480I/480P)

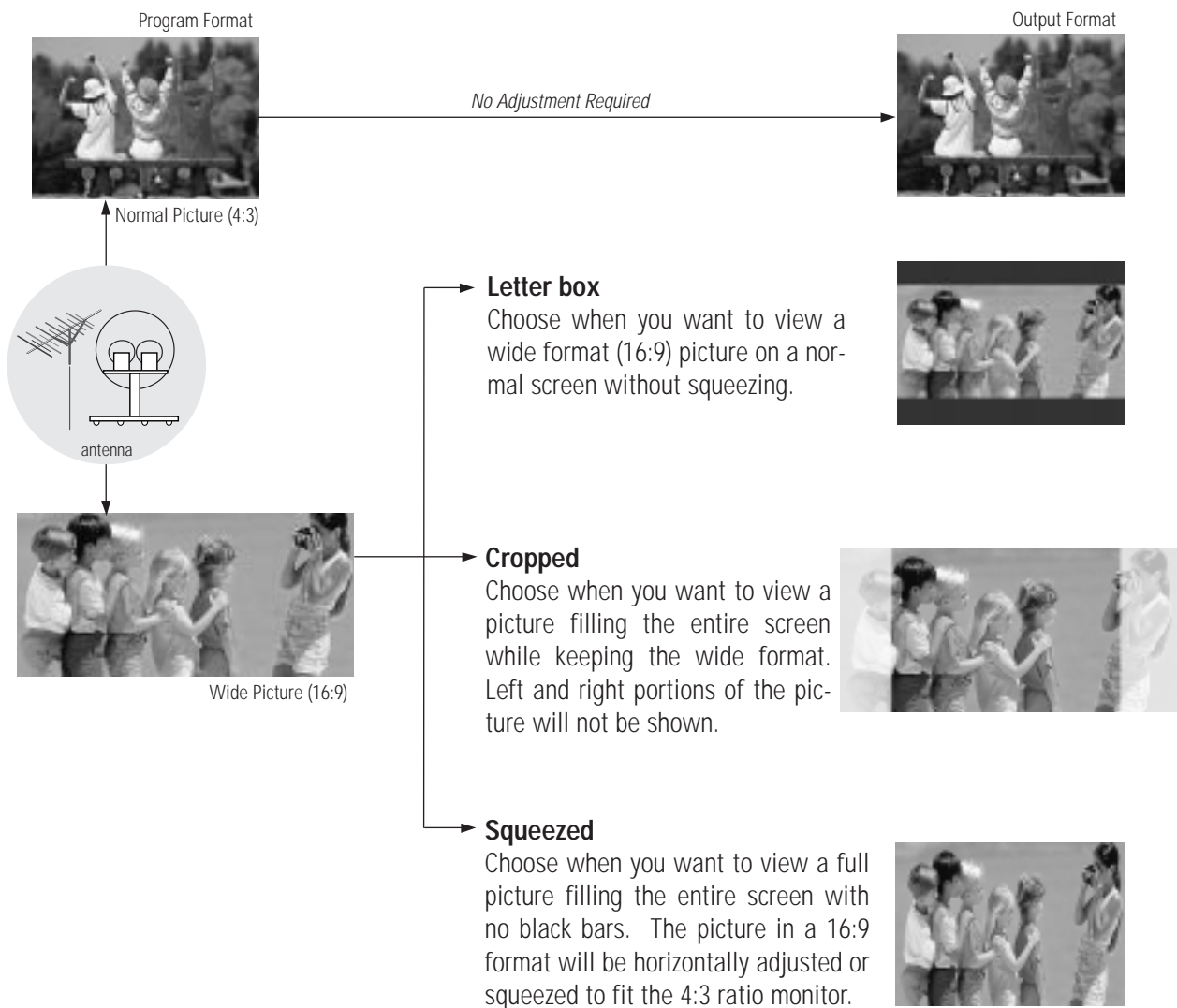

2-3. Normal and Wide Format Signals

WHEN YOU SET THE DISPLAY SWITCH TO HDTV (1080I/720P)



Wide Picture (16:9)

No Adjustment Required



Output Format (16:9)

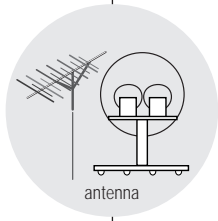

Normal Picture (4:3)

Adjustment
Required

Normal

Choose when you want to view a picture with an original 4:3 aspect ratio on your 16:9 TV. Black bars will show at the left and right sides.



Wide

Choose when you want evenly stretch the width of a normal picture to fill a wide screen to fill the entire screen. You may find this setting useful for viewing 4:3 formatted DVD pictures.



Panorama

Choose when you want stretch the edges of a normal picture to fill a wide screen.



Zoom1

Choose when you want to fill the entire screen with the picture. The image will be altered both horizontally (stretched) and vertically (cropped). The top and bottom portions of the picture will not be shown. Zoom1 shows you the picture with a trade-off between distortion and screen coverage.



Zoom2

Choose when you want to view the picture without distortion. Some of the top and bottom portions of the picture will be deleted.



2. IMPORTANT OVERVIEW

2-4. Audio Signals

Digital Audio Signals

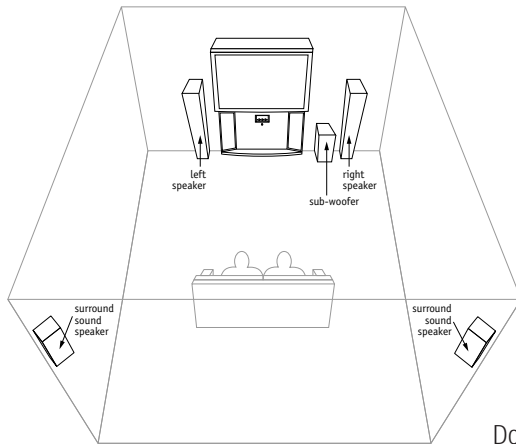

Dolby Digital Sound with 5.1 Channels

The Zenith HD Satellite Receiver will be the focal center of your home entertainment system comprising a variety of components, such as TV, DVD, VCR, etc. and external audio systems. Since digital programs being broadcast contain digital-quality audio, you can create a home theater by sending audio signals from the HD satellite receiver to your audio system externally. HD digital signals use the Dolby Digital audio encoding system - the same digital sound used in most movie theaters, on DVDs, and in many home theater systems.

When you tune to a channel, the Zenith HD Satellite Receiver can send signals either to a Dolby Digital decoder/receiver or to a PCM (normal digital) decoder. (* Refer to Section 3.7 Connection for Audio for making the required external connections to your system.)

Using the analog mode of the Zenith HD Satellite Receiver allows use of your Hi-Fi audio system instead of the TV speakers. This usually results in substantially improved sound.

GLOSSARY

Dolby Digital, formally known as AC-3 for Audio Coding 3rd Generation or "5.1" channel audio, is a coding technique that provides five independent, full frequency response audio channels (three in left, center, and right, two in rear left and right, and one low frequency effect for a sound you can feel).

Pulse Code Modulation (PCM) decoders support L/R stereo only. If selected, audio outputs are decoded and transmitted in PCM mode.

2-4. Audio Signals

Analog Audio Signals

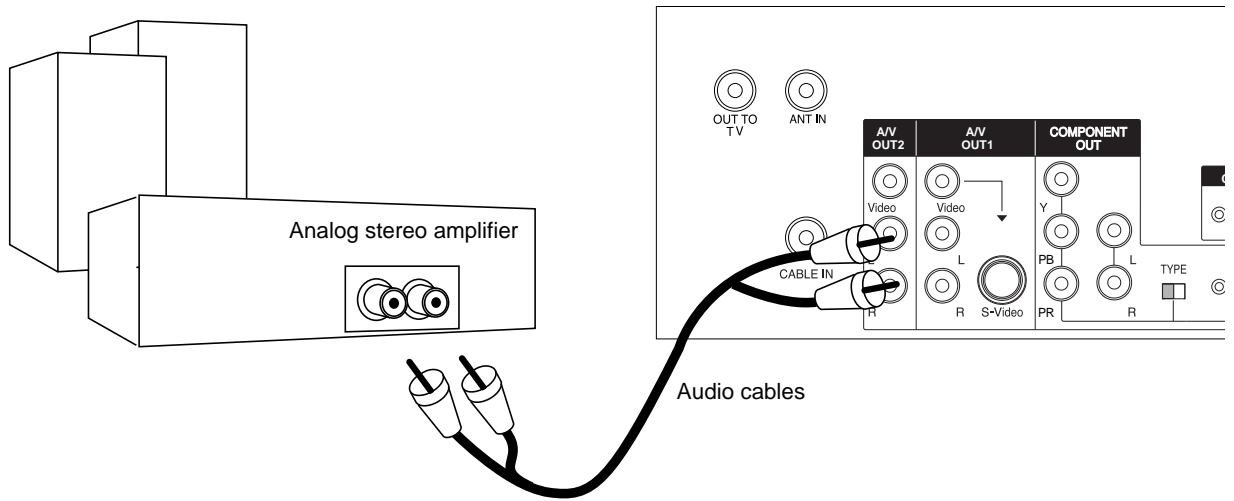

The analog audio outputs may be used to drive an external audio system. These stereo outputs are activated by setting the Analog mode in the Audio menu to Stereo.

If you set the Analog Mode to SAP (Second Audio Program), you can hear the program's dialog in another language such as French or Spanish, if provided on the broadcast.

2. IMPORTANT OVERVIEW

2-5. On-Screen Display

Main Menu

You can adjust the setup through a user-friendly on-screen menu using the remote control. While viewing a program, the on-screen menu will appear on your TV screen if you press the **Menu** button on your remote control. The on-screen menu is operated using a simple, straight-forward 'Highlight and Select' process. You just highlight a menu item by using "▲▼◀▶" on the thumbstick of your remote control, and select it by pressing **⊙**. The on-screen menu also offers visual cues for easy guidance.



Advanced Program Guide™

The Advanced Program Guide™ is an on-screen listing of current and future programs that are available from DIRECTV. The Zenith HD Satellite Receiver offers you a comprehensive program list that contains about programs with hundreds of channels, including analog Antenna and digital (ATSC). If you do not subscribe to DIRECTV® programming, you will not be able to see the APG.



2-5. On-Screen Display

EZ Help

First, certain features and terminology used in the on-screen menus require your basic understanding to fully utilize their capabilities. The Zenith HD Satellite Receiver provides a powerful feature called “EZ Help” that describes highlighted menu item to help you understand the features. Press and hold the “**Help (?)**” button to display the “EZ Help”. Once you release the button, it disappears from the screen.



Second, if you press the “**Help (?)**” button while you are viewing a program with no menus on-screen, the Zenith HD Satellite Receiver provides a comprehensive on-screen user’s guide. It describes how to use your receiver.

This is, in fact, an on-line version of this Operating Guide.

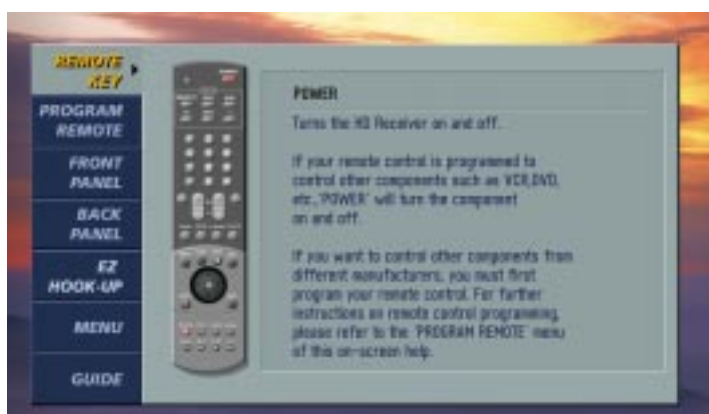

3. SETUP AND CONNECTIONS

3-1. Unpacking

Make sure you have received all these items listed below with the Zenith HD Satellite Receiver.

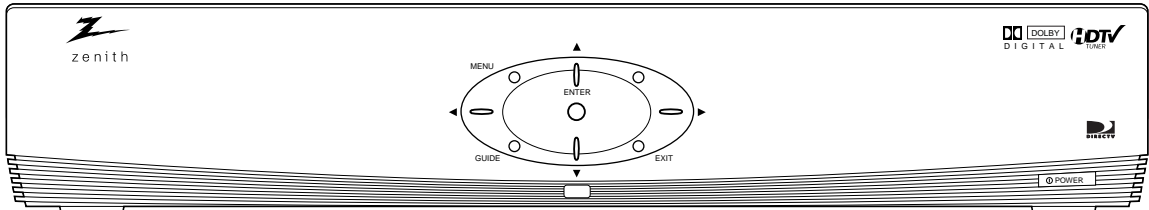

Remote Control

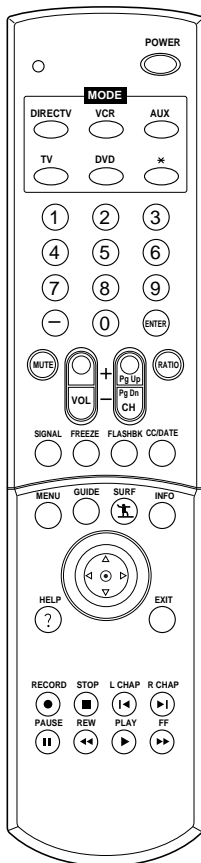

Cables (6 items)

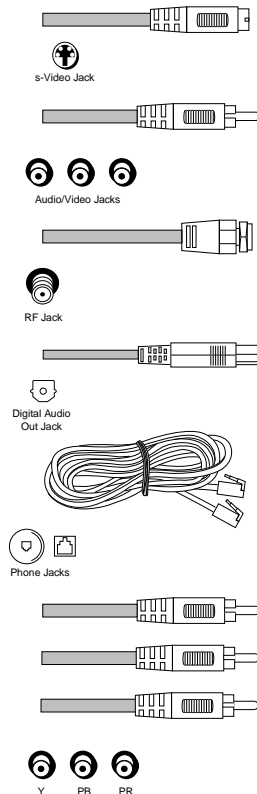

Batteries

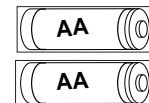

3-1. Unpacking

HD satellite receiver

The Zenith HD Satellite Receiver is capable of receiving signals from the satellite dish, cable, and/or over-the-air antenna and sending the decoder signals into your TV.

Remote Control

In addition to the Zenith HD Satellite Receiver, the remote control can be programmed to control many other Zenith and non-Zenith devices.

Batteries

To install the batteries, slide open the battery compartment and insert the two AA batteries provided.

S-Video Jack and Cable

An S-Video jack is provided on the HD satellite receiver and is used together with audio cables. Remember to connect the left and right audio cables. An S-Video jack carries only the picture signals, not the sound.

Audio/Video Jacks and Cables

The Audio/Video jacks provide excellent picture and sound quality. They are used for making most Audio/Video connections between components. The Audio/Video jacks may be color coded (yellow for video, red for right audio, and white for left audio). If your component has only one input for audio (mono), connect it to the left (white L/mono) audio jack on the HD satellite receiver.

RF (Radio Frequency) Jacks and Coaxial Cables (F-type)

RF jacks are necessary for reception of over-the-air broadcasts, cable, and DIRECTV signals. These jacks are also required for antenna or cable connections. The RF and coaxial jacks on the HD satellite receiver are labeled Antenna, Cable, Satellite and OUT TO TV. An RG-6 type coaxial cable is required for satellite signal distribution.

Digital Audio Out Jacks and Cables

The optical cable and coaxial cable are used for connecting a Dolby Digital receiver. If you own a Dolby Digital receiver that uses an optical cable input, use an optical cable to connect the HD satellite receiver to that receiver.

Telephone Jack and Cord

The telephone line cord is required to connect your HD satellite receiver to a phone line. If you choose to subscribe to DIRECTV® programming, this phone line is required to be connected.

Component Out Jacks and Cables

Component Cables are used to connect your HD satellite receiver to an industry standard Y PB PR compatible HD Monitor. A VGA cable can be also used to connect the HD satellite receiver to an industry-standard RGB-compatible monitor Via the HD Monitor Out jack (not included in this package).

3. SETUP AND CONNECTIONS

3-2. Back Panel of the Zenith HD Satellite Receiver

Zenith HD Satellite Receiver Model DTV1080 Rear Panel

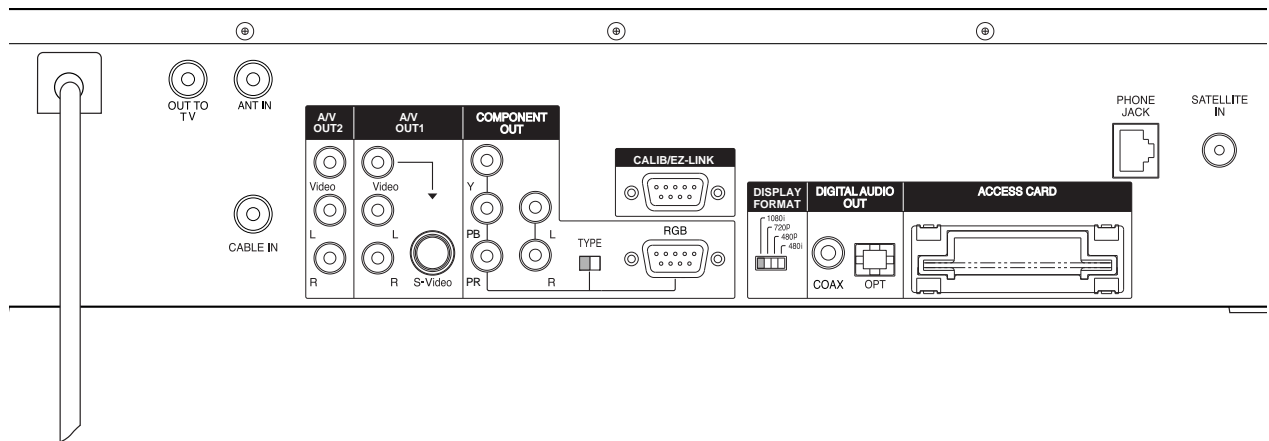

3-2. Back Panel of the Zenith HD Satellite Receiver

Ant In

Is used to connect an over-the-air or terrestrial antenna, your cable TV outlet, or cable box.

Cable In

Is used to connect a coaxial cable coming from your cable TV service outlet or cable box.

Out to TV

Provides an RF connection between the Zenith HD Satellite Receiver and the TV. Decoded signals are provided on channel 3 or 4 as selected in the menu. If the Zenith HD Satellite Receiver is in the stand-by mode, Cable or Antenna signals are provided as chosen in the Out to TV section of the Preference menu.

A/V Out 1,2

Is used to provide baseband audio and video signals to VCR or TV set. A/V connections generally provide picture quality that is superior to RF connections. For the highest quality picture connection, use the S-Video jack if it is available.

Component Out

Is used to connect to either a Y/PB/PR-compatible or RGB-compatible HD monitor. Either three video and two audio jacks for a Y/PB/PR monitor or a RGB jack for a RGB monitor need to be connected and the selector must be set accordingly.

Display Format

Sets the output resolution to one of 1080i, 720p, 480p and 480i formats. Choose the correct display format for your TV.

Digital Audio Out

Is used to connect either a digital optical cable or a coaxial cable from the HD satellite receiver to the Dolby Digital receiver or decoder. Dolby Digital enables the viewer to experience theater-quality sound using 5.1 audio channels.

EZ Link

Is the connection for the Zenith EZ Link.

Access Card

The access card is the means by which DIRECTV controls the distribution of its services. The card must be inserted into the access card slot (on the rear panel of the receiver) at all times to enable operation of the Zenith HD Satellite Receiver.

Phone Jack

Is used to receive certain premium services.

Satellite In

Is used to connect a satellite dish antenna to your receiver.

3. SETUP AND CONNECTIONS

3-3. General Recommendations

CAUTION: Make all connections before plugging the power supply cord into a standard 120V, 60Hz AC power outlet.

You can connect the HD satellite receiver in a variety of configurations. The answers to the following questions will determine the correct setup for you.

- What type of antennas do you have? Satellite dish, cable, and/or over-the-air antennas.
- What type of connectors does your TV or VCR have: S-VIDEO, A/V (RCA_type), or RF coaxial?
- Do you want to use your HD satellite receiver with your audio or video systems?
- Do you have an audio or audio/video system? Consider integrating the HD satellite receiver into a home theater configuration to take advantage of the audio capabilities of your Dolby Digital System (Digital) or Hi-Fi System (Analog).
- Does your TV have an S-VIDEO jack? Use it to connect your TV to the HD satellite receiver. An S-VIDEO connection provides a better picture than RCA_type video or RF connections.
- Does your TV have RCA type A/V connectors, but no S-video jack? Use your TV's A/V connectors to connect your components. An A/V connection provides better picture and audio when compared to an RF connection.

Although there are numerous connections possible for optimum video and audio performance, try to follow the guidelines listed below when you hook up your components. Detailed hook-up instructions are provided on the following pages.

Connection	Component	Page
To Antennas	No Dish	23
	Round Dish (Satellite A)	24
	Oval Dish (Satellite A, B)	25
	Oval Dish (Satellite A, B, C)	26
To TV	Analog TV	27
	HD Monitor (Y/PB/PR type)	28
	HD Monitor (RGB type)	29
To A/V Systems	VCR	30
	Digital Audio System	31
	Analog Hi-Fi System	32



Protect your components from power surges by turning off the component and unplugging power cords when you make connections.

Protect your component from overheating by keeping the ventilation holes open and not stacking components.

3-4. Connecting to Antennas - No Dish

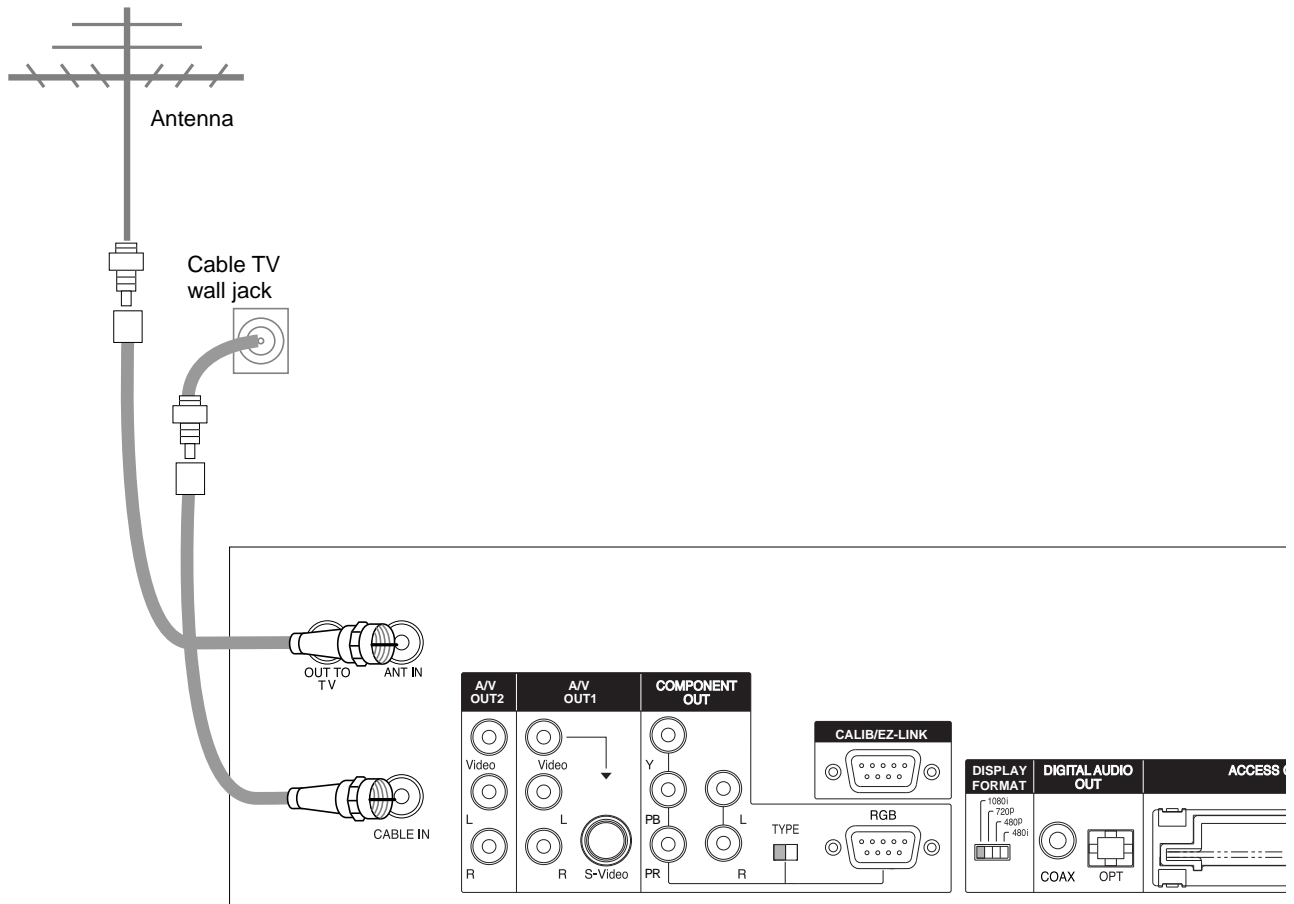

Receiving Signals

1. Connect the "Antenna" to the "ANT IN" jack on the HD Satellite Receiver using a coaxial RF cable.
2. Connect the cable TV signal to the "CABLE IN" jack of the HD Satellite Receiver using a coaxial RF cable.

3. SETUP AND CONNECTIONS

3-4. Connecting to Antennas - Round Dish (Satellite A)

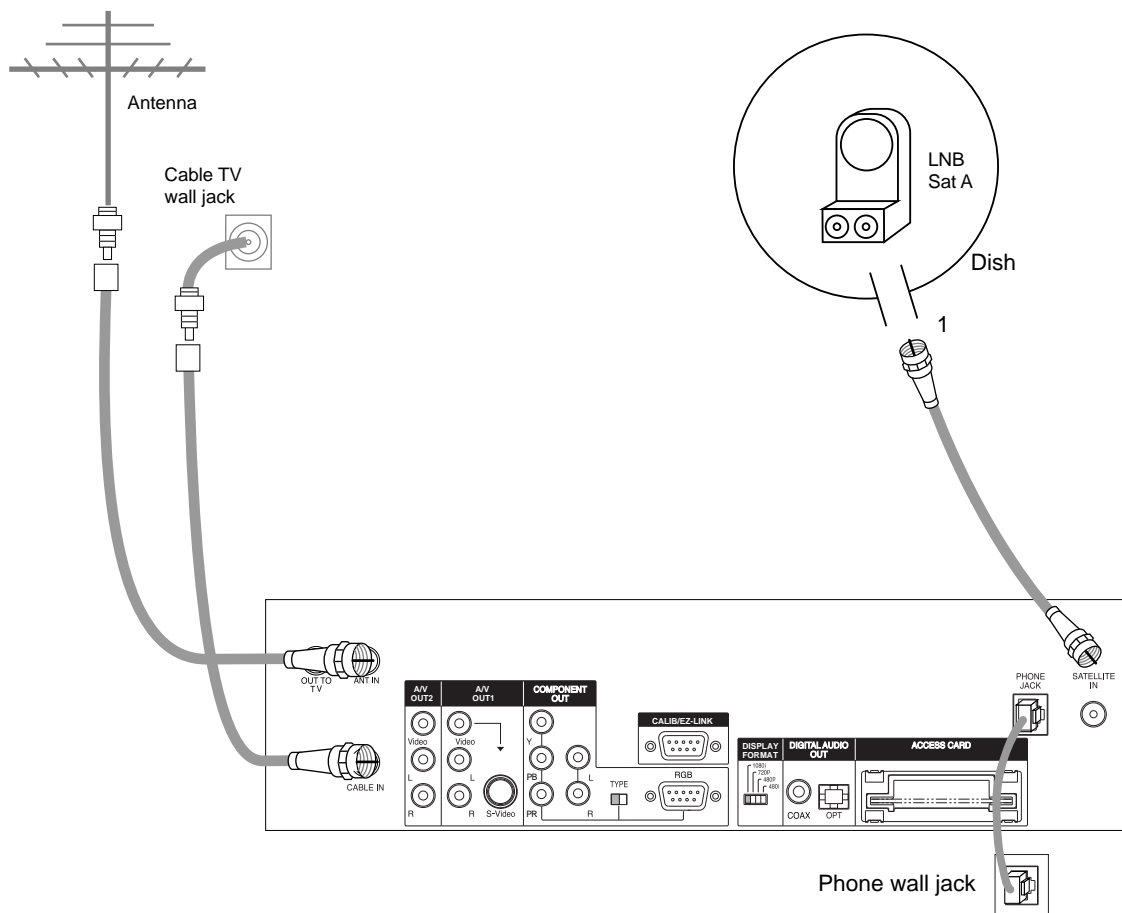

Receiving Signals

1. Connect the "Antenna" to the "ANT IN" jack on the HD Satellite Receiver using a coaxial RF cable.
2. Connect the cable TV signal to the "CABLE IN" jack on the Zenith HD Satellite Receiver using a coaxial RF cable.
3. Connect the "Jack 1" of the dish antenna to the "SATELLITE IN" jack on the HD Satellite Receiver using a coaxial RF cable. (For proper dish installation, refer to the "Installer's Guide" provided with your satellite dish antenna.)
4. Connect the "Phone Wall Jack" to "PHONE JACK" on the HD Satellite Receiver using a phone cable.

NOTE

While you are subscribing to a DIRECTV® programming package, you can still view over-the-air and cable TV programs, if you make connections to the over-the-air and/or cable jacks.

NOTE

You will not be able to receive DIRECTV HD programming with a Round dish.

3-4. Connecting to Antennas - Oval Dish (Satellite A, B)

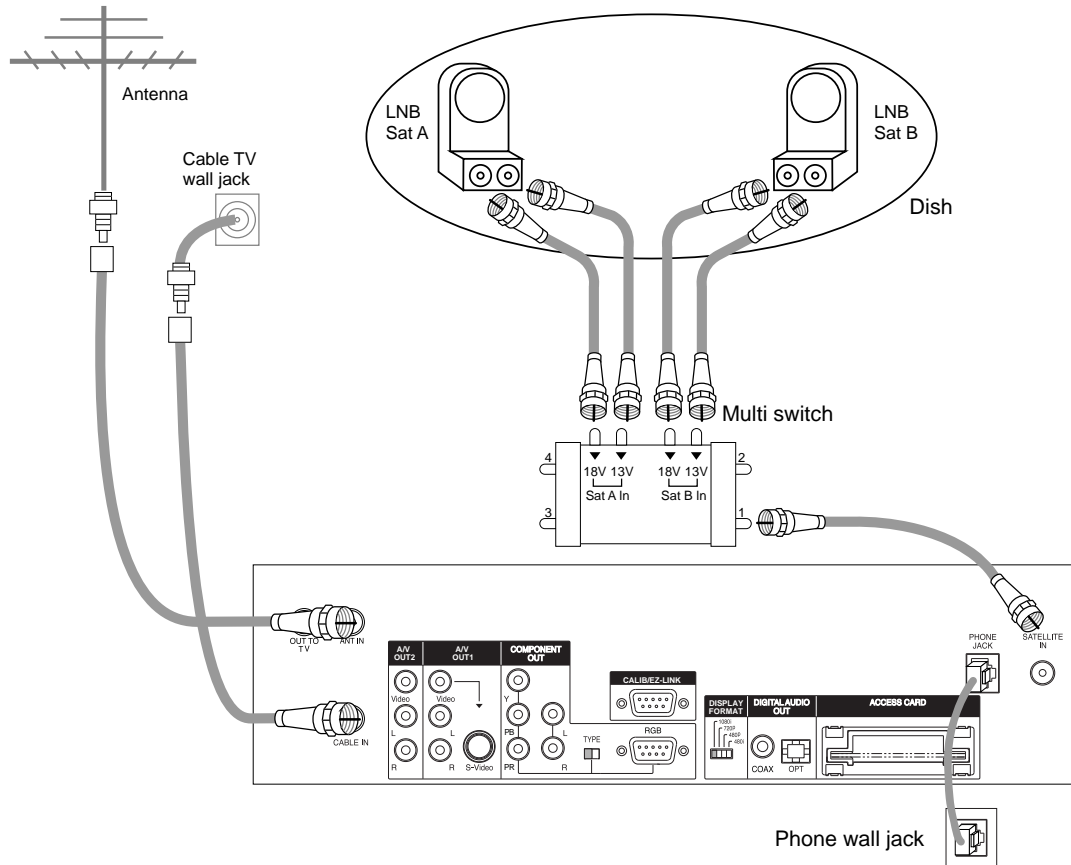

Receiving Signals

1. Connect the "Antenna" to the "ANT IN" jack on the HD Satellite Receiver using a coaxial RF cable.
2. Connect the cable TV signal to the "CABLE IN" jack on the HD Satellite Receiver using a coaxial RF cable.
3. Connect the "Jack 1" of the multi-switch to the "SATELLITE IN" jack on the HD satellite receiver using a coaxial RF cable. (For proper dish installation, refer to the "Installer's Guide" provided with your satellite dish antenna.)
4. Connect the "Phone Wall Jack" to "PHONE JACK" on the HD satellite receiver using a phone cable.

NOTE

While you are subscribing to a DIRECTV® programming package, you can still view over-the-air and cable TV programs, if you make connections to the over-the-air and/or cable jacks.

3. SETUP AND CONNECTIONS

3-4. Connecting to Antennas - Oval Dish (Satellite A, B, C)

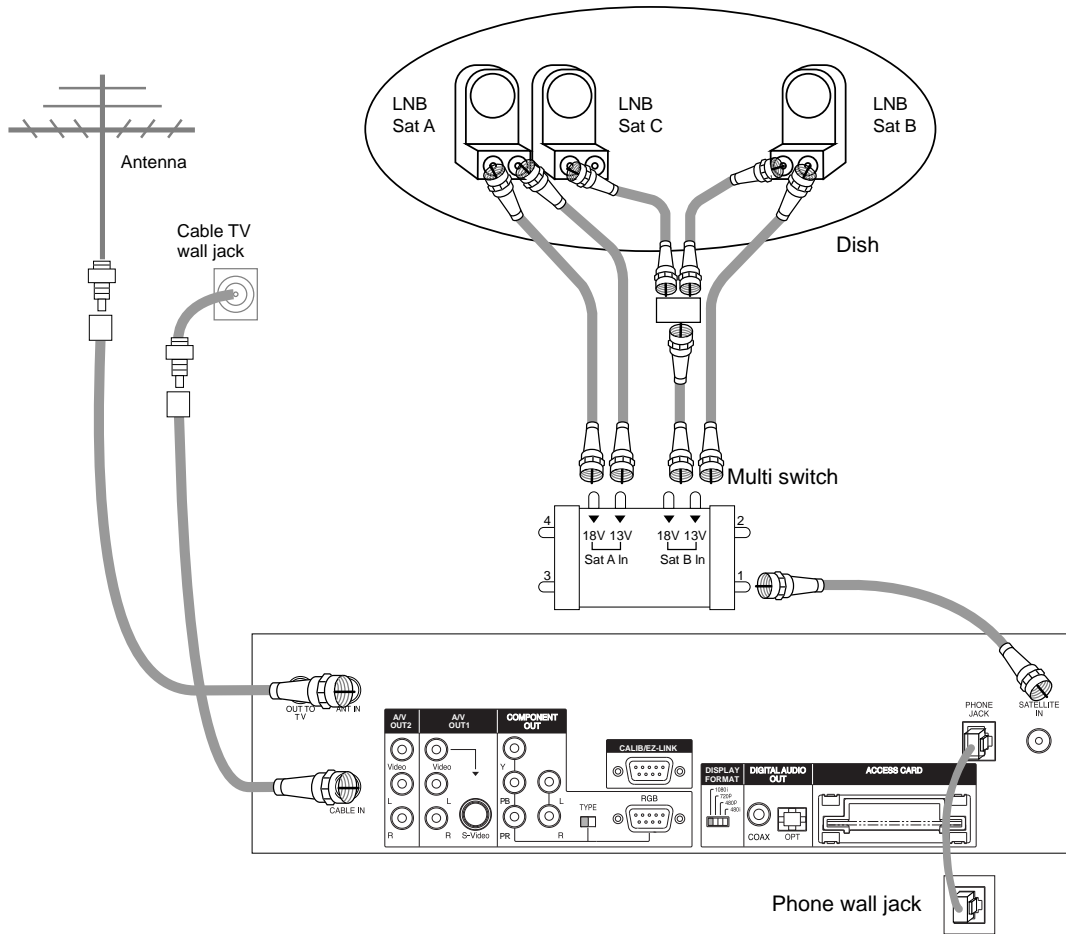

Receiving Signals

1. Connect the "Antenna" to the "ANT IN" jack on the HD Satellite Receiver using a coaxial RF cable.
2. Connect the cable TV signal to the "CABLE IN" jack on the HD Satellite Receiver using a coaxial RF cable.
3. Connect the "Jack 1" of the multi-switch to the "SATELLITE IN" jack on the HD Satellite Receiver using a coaxial RF cable. (For proper dish installation, refer to the "Installer's Guide" provided with your satellite dish antenna.)
4. Connect the "Phone Wall Jack" to "PHONE JACK" on the HD Satellite Receiver using a phone cable.

NOTE

While you are subscribing to a DIRECTV® programming package, you can still view over-the-air and cable TV programs, if you make connections to the over-the-air and/or cable jacks.

3-5. TV Connection - Analog TV

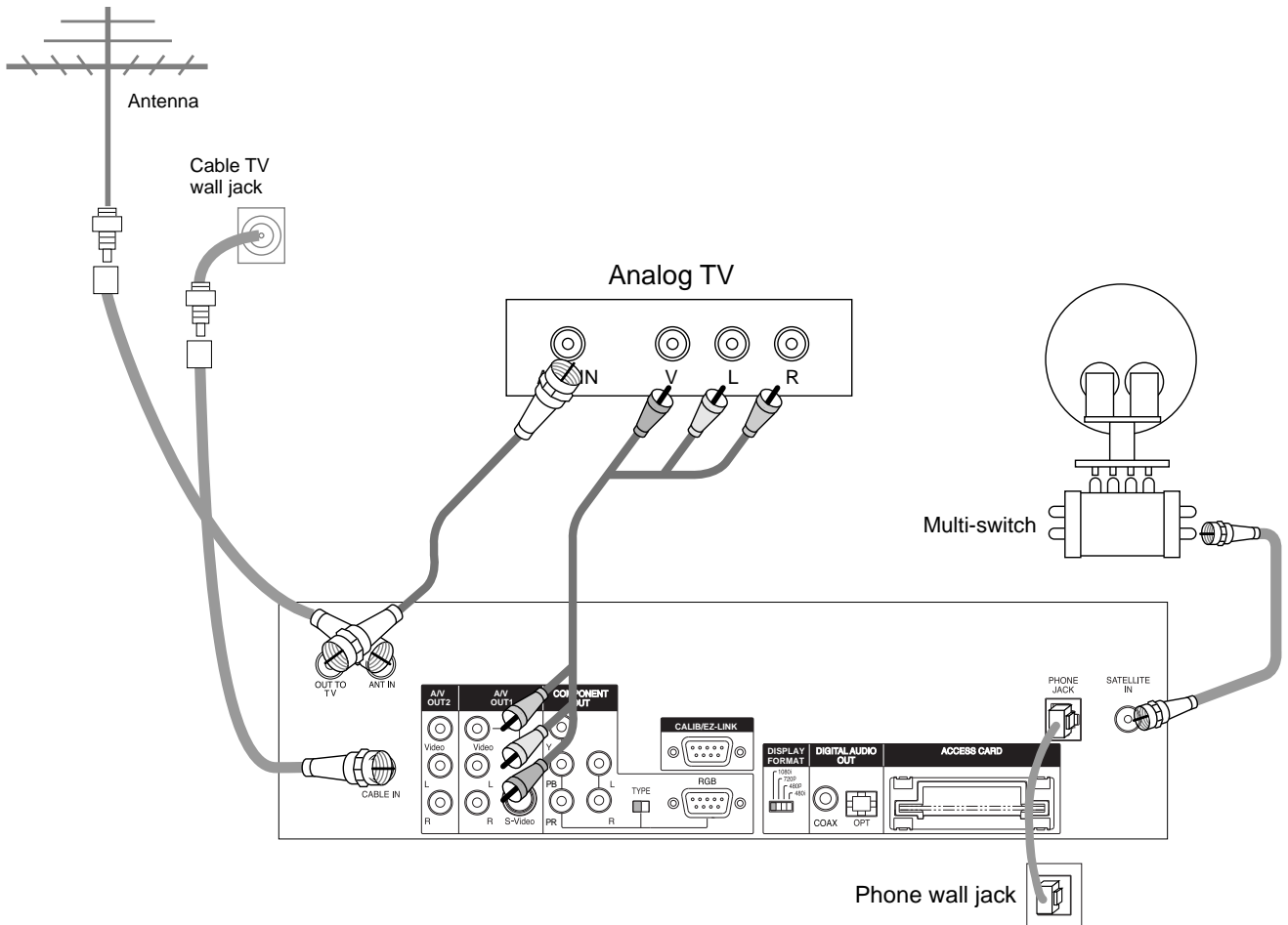

TV Viewing

1. Connect the "OUT TO TV" jack on the HD satellite receiver to the "ANT IN" jack on your TV using a coaxial RF cable.
2. Connect the "A/V OUT" jack on the HD satellite receiver to the "A/V IN" jack on your TV using RCA_type cables.

3. SETUP AND CONNECTIONS

3-5. TV Connection - HD Monitor (Y/PB/PR type)

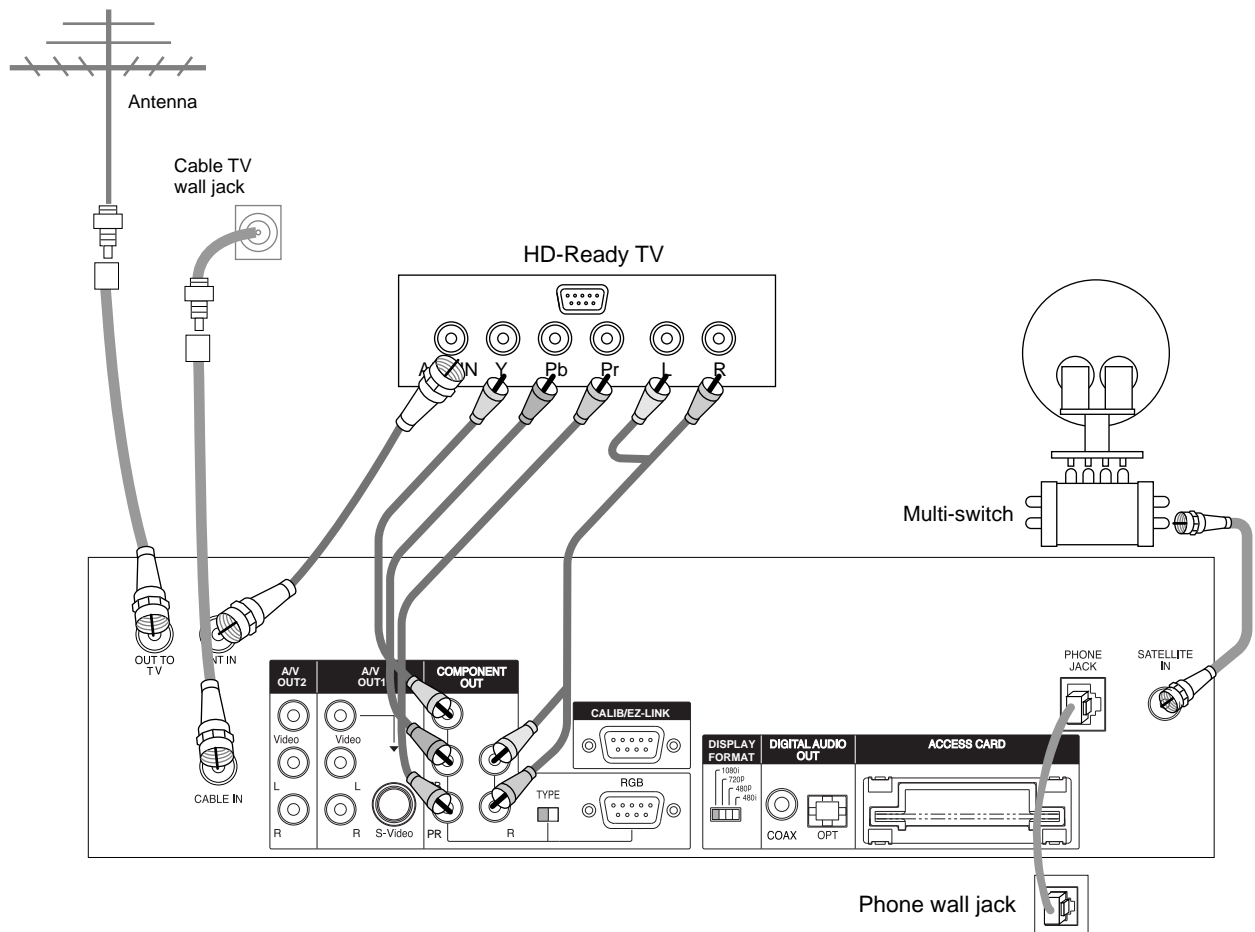

TV Viewing

1. Connect the "OUT TO TV" jack on the HD Satellite Receiver to the "ANT IN" jack on your TV using a coaxial RF cable.
2. Connect the "COMPONENT OUT" jacks on the HD Satellite Receiver to the "COMPONENT IN" jacks of your TV using RCA_type cables. (The "TYPE" switch must be set toward the "Y/PB/PR" jacks.)
3. Connect the L/R "COMPONENT OUT" jacks on the HD Satellite Receiver to the L/R "COMPONENT IN" jacks on your TV using RCA_type connectors.

3-5. TV Connection - HD Monitor (RGB type)

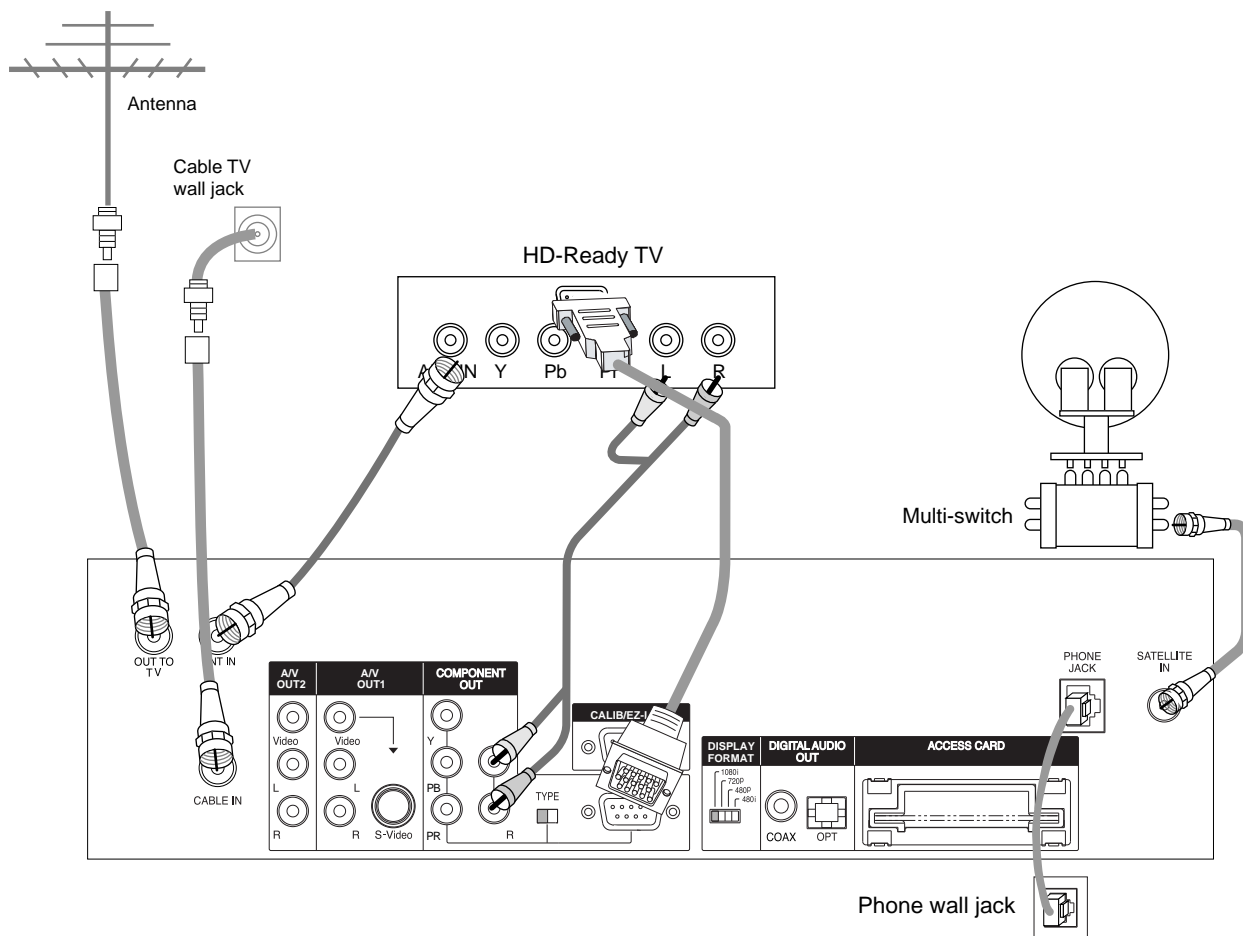

TV Viewing

1. Connect the "OUT TO TV" jack on the HD Satellite Receiver to the "ANT IN" jack on your TV using a coaxial RF cable.
2. Connect the "COMPONENT OUT" jacks on the HD Satellite Receiver to the "COMPONENT IN" jacks of your TV using RCA_type cables. (The "TYPE" switch must be set toward the "RGB" jacks.)
3. Connect the L/R "COMPONENT OUT" jacks on the HD Satellite Receiver to the L/R "COMPONENT IN" jacks on your TV using RCA_type connectors.

3. SETUP AND CONNECTIONS

3-6. VCR Connection

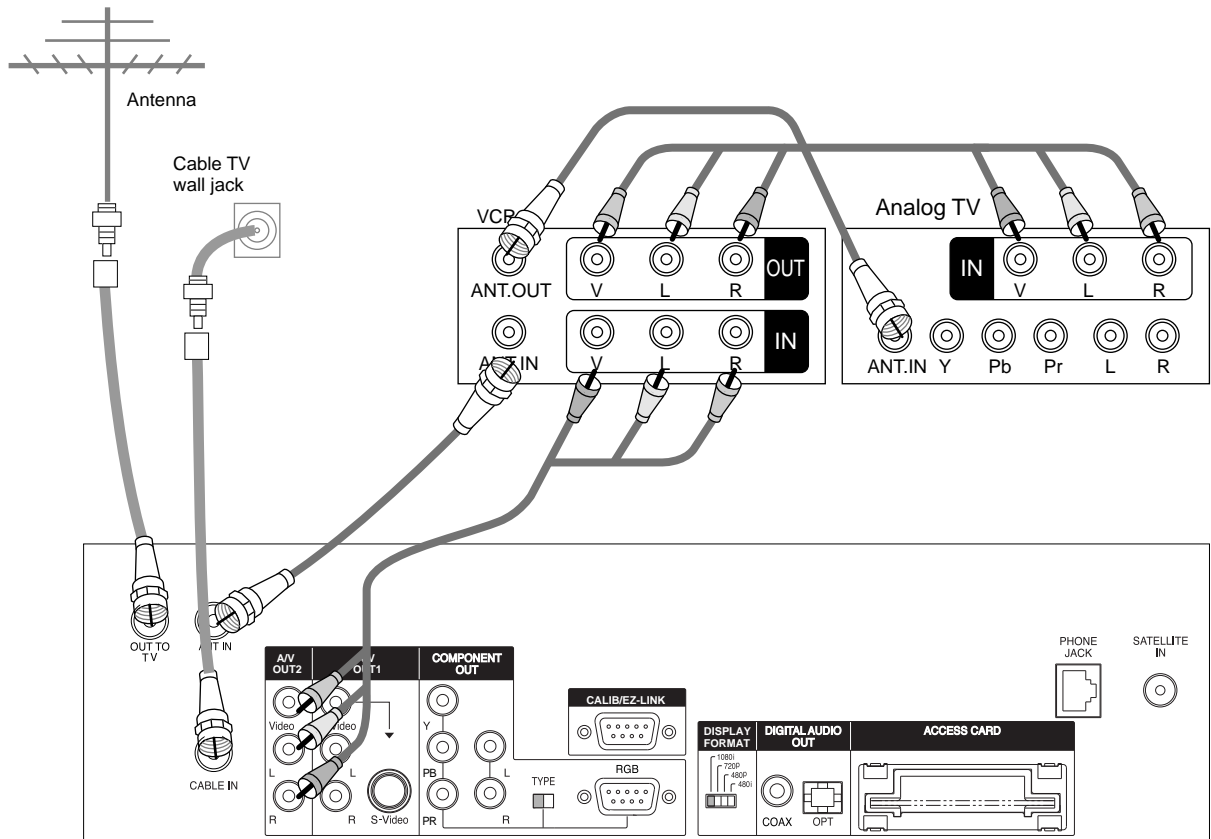

TV Viewing

Refer to Section 3.5, 'Connecting to TV'

VCR Recording

1. Connect the "OUT TO TV" jack on the HD satellite receiver to the "ANT IN" jack on your VCR using a coaxial RF cable.
2. Connect the "ANT.OUT" jack on your VCR to the "ANT.IN" jack on your TV using a coaxial RF cable.
3. Connect the "A/V OUT" jack on the HD satellite receiver to the "A/V IN" jack on your VCR using a RCA_type cable. (If your VCR is equipped with an S-Video jack, use the "A/V OUT" jack; otherwise, use the "OUT TO VCR" jack.)
4. Connect the "A/V OUT" or "OUT TO VCR" jack on your VCR to the "A/V IN" jack on your TV using a RCA_type cable.

3-7. Audio Connection - Digital Audio System

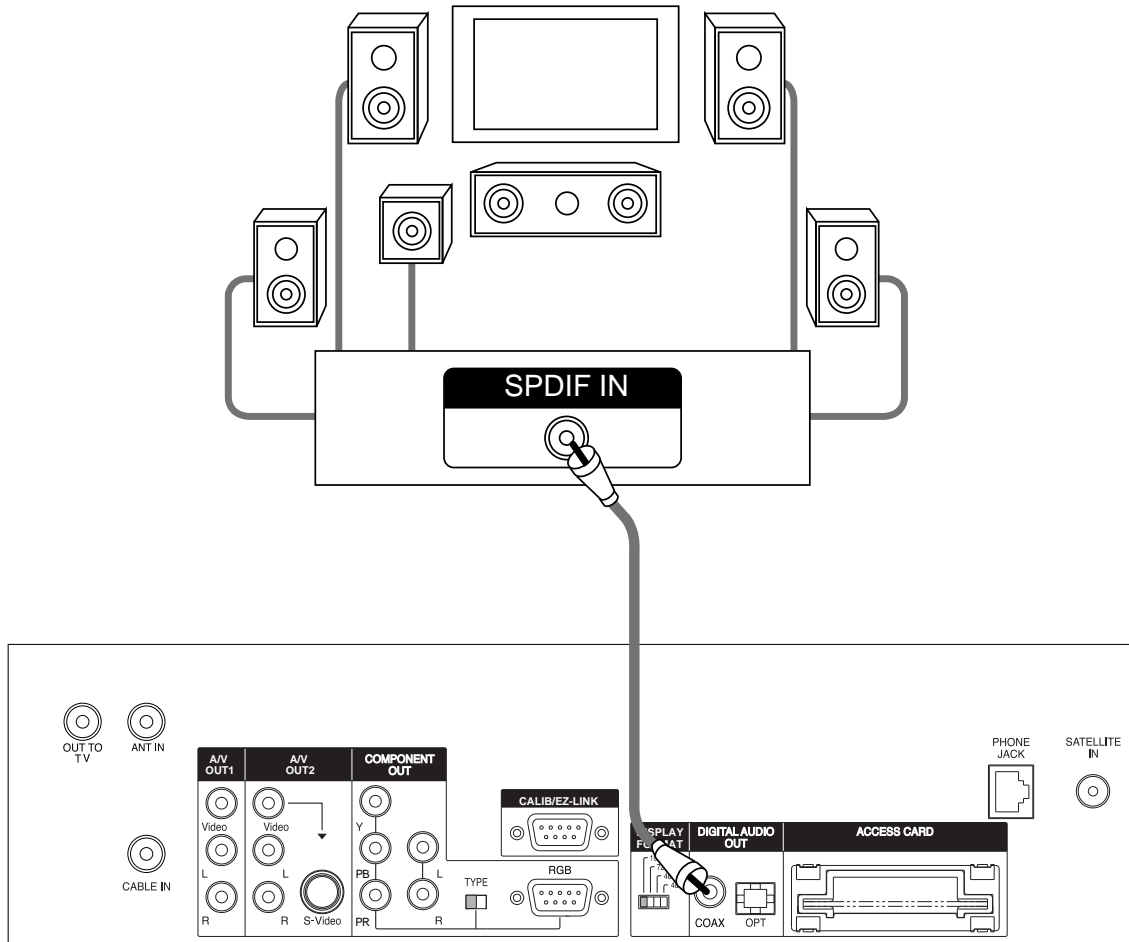

Dolby AC-3 Connection

1. Connect the "DIGITAL AUDIO OUT" jack on the HD satellite receiver to the "SPDIF IN" jack on your Dolby Digital decoder using a digital audio cable.

3. SETUP AND CONNECTIONS

3-7. Audio connection - Analog Hi-Fi System

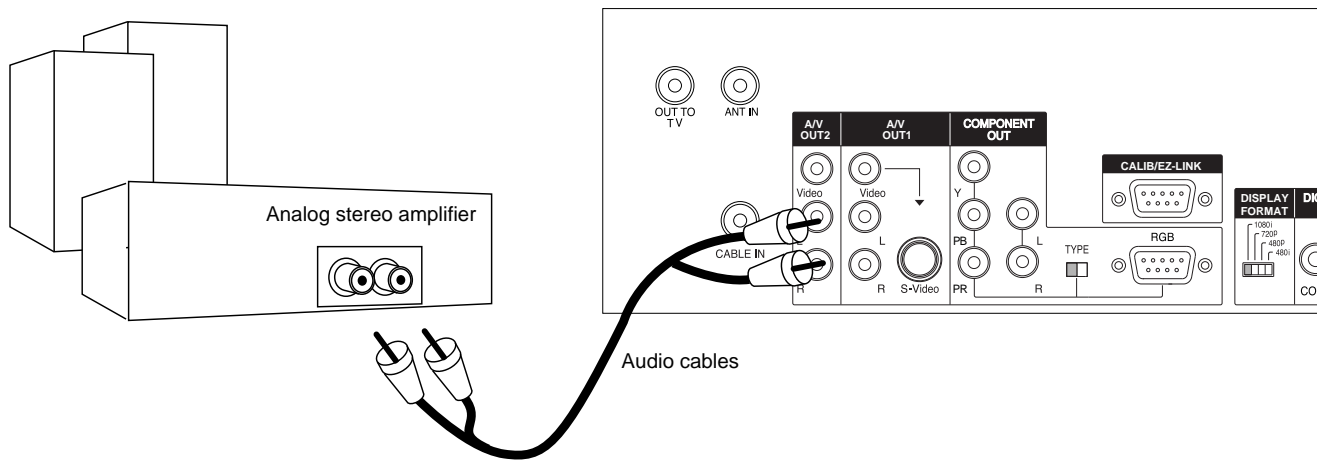

Hi-Fi System Connection

1. Connect the Left and Right "A/V OUT" jacks of the Zenith HD Satellite Receiver to the Left and Right "INPUT" jacks on your Hi-Fi audio system.

4. ZENITH HD SATELLITE RECEIVER OPERATION

4-1. Using the Front Panel of the HD satellite receiver

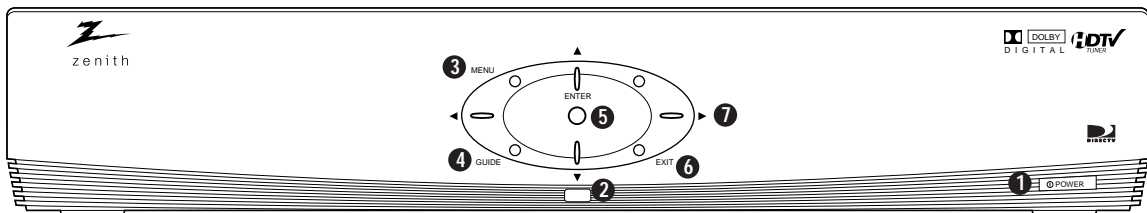

- 1 Power**
Turns the HD satellite receiver on or off.
- 2 Remote Control Sensor**
Receives signals from the remote control
- 3 Menu**
Shows the main menu on the screen. You can return to normal viewing by pressing the **Exit** button.
- 4 Guide**
Displays the DIRECTV Advanced Program Guide™ screen that shows you a program schedule containing a list of current and future programs. You can also access the Advanced Program Guide™ using the main menu by pressing the **Menu** button and arrow keys. You can return to normal viewing by pressing **Exit**.
- 5 Enter (⊙)**
If the main menu is displayed, pressing the Enter key will activate the selected MENU item. During normal viewing when the menu is not displayed, pressing the Enter key will display your current settings and preferences.
- 6 Exit**
Clears all on-screen displays and returns to normal viewing from any menu.
- 7 Arrow Keys**
Allows you to navigate on-screen menus and to adjust the system settings and preferences. Use the arrow keys to move to a menu option and then use the select button to access it.

4. ZENITH HD SATELLITE RECEIVER OPERATION

4-2. Using the Remote Control

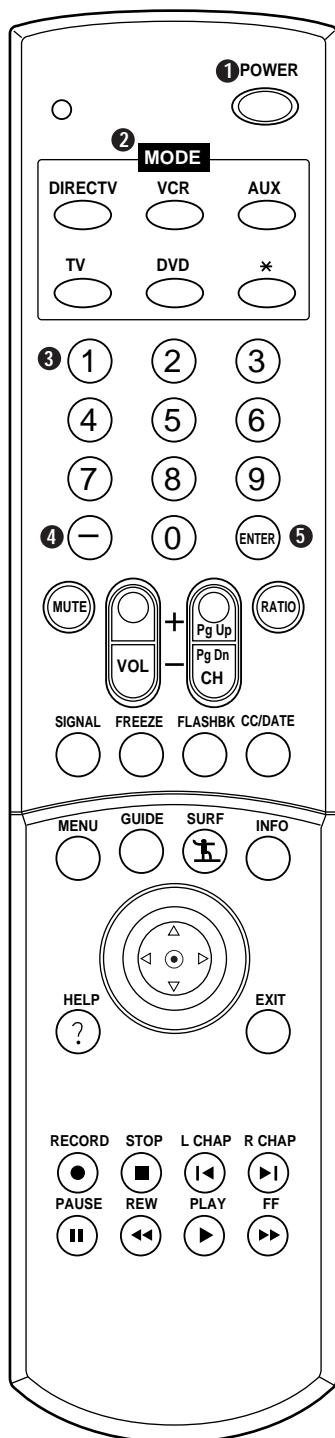

1 Power

Turns the HD satellite receiver on and off. If your remote control is programmed to control other components such as VCR, DVD, etc., Power will turn the component on and off. If you want to control other components from different manufacturers, you must first program your remote control. For further instructions on remote control programming, please refer to the section 4.3 of this operating guide or the Program Remote section of on-screen help.

2 Mode

Selects the component that will be controlled by the remote. For example, if your remote control is set to VCR, the **CH +/-** button will change the channel number of the VCR. If you want to control other components from different manufacturers, you must first program your remote control.

3 Digit Buttons (0-9)

Allows you to enter channel numbers for direct tuning or to scroll to the designated page of the program list on the Guide menu. Digit buttons can be used to enter numerical values wherever required e.g, to enter a password.

4 Dash (-)

Is used to enter a channel number for multiple program channels such as 2-1, 2-2, etc. A broadcaster may transmit multiple programs on a single channel. Multiple programs are distinguished by a unique sub-channel number, separated by a dash (-).

5 Enter (⊙)

Use with numbered buttons for instant channel selection. When you press a channel number, for example, 22, the receiver awaits another stroke for three seconds and then tunes to 22.

4-2. Using the Remote Control

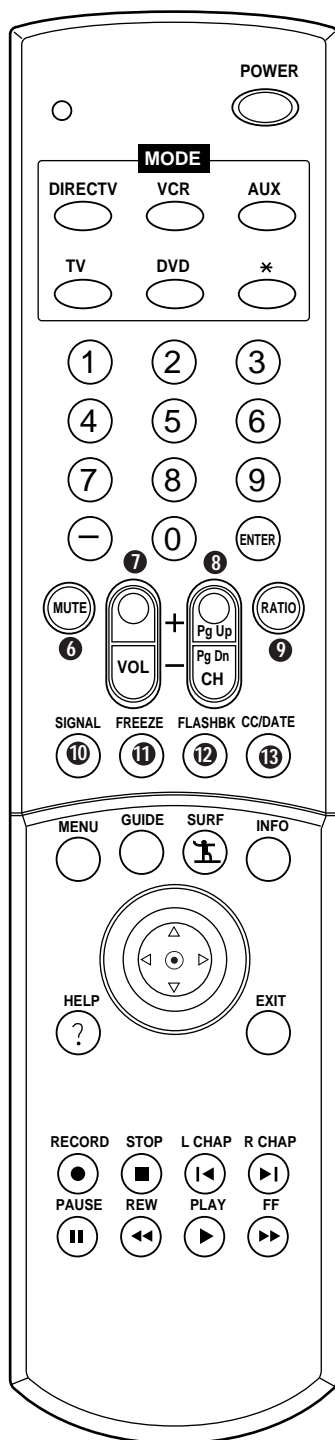

6 Mute

Is used to temporarily turn off the sound. Press again to restore the sound.

7 Vol +/-

Increase/decrease the sound level of the HD satellite receiver.

8 CH +/-

Scrolls the channels up or down while you are viewing a program, or scrolls the program list in the Guide menu page by page. Press and hold the button to speed up and continue scrolling channels.

9 Ratio

Changes the displaying options. When you view a picture with a wide (16:9) aspect ratio in 480i or 480p format, the button changes the displaying options in the cycle of Letterbox, Cropped, to Squeezed. When you view a picture with a normal (4:3) aspect ratio in 720p or 1080i format, the button changes the screen format in the cycle of Normal, Wide, Panorama, Zoom1 and Zoom2. Detailed descriptions of the TV aspect ratios are given in section 2.3 or the TV Aspect Ratio of the Preference menu.

10 Signal

Shows the signal strength of the current channel, if it is a digital over-the-air channel or satellite channel. You may improve the signal strength by adjusting the direction of your over-the-air antenna.

11 Freeze

Freezes the current picture. Press again to resume motion.

12 Flashbk (Flash Back)

Returns to the last channel viewed. Allows you to move back and forth between the last two channels viewed.

13 CC/Date (Closed Caption)

Lets you turn closed caption on or off. The closed caption mode can be selected in the Closed Caption section of the Preference menu. You can also change the date by pressing the **CC/Date** button in the Advanced Program Guide™.

NOTE : Closed Caption will appear only when it is provided by the broadcaster.

4. ZENITH HD SATELLITE RECEIVER OPERATION

4-2. Using the Remote Control

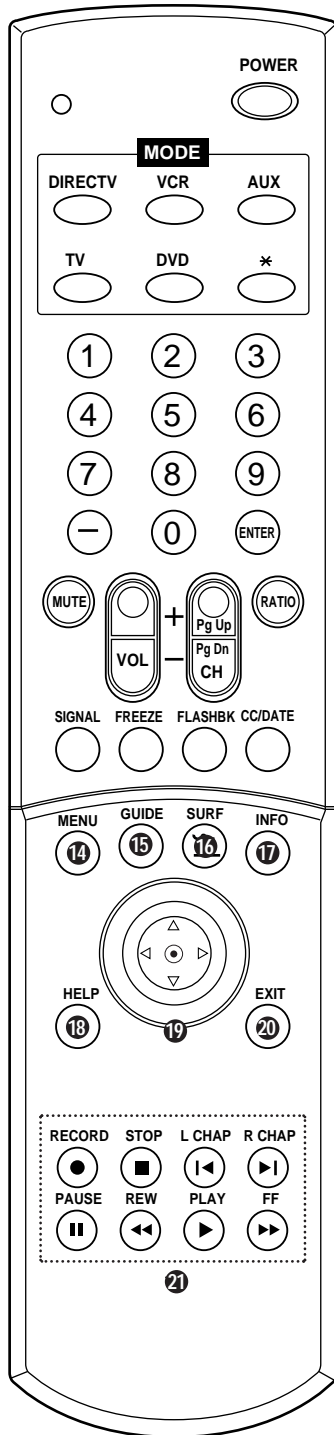

14 Menu

Brings up the main menu. You can return to normal viewing by pressing the **Exit** button or pressing the **Menu** button again.

15 Guide

Brings up the DIRECTV Advanced Program Guide™. You can also access the Advanced Program Guide™ via the main menu. Return to normal viewing by pressing the **Exit** button or pressing the **Guide** button again.

16 Surf

Shows the list of your surf channels. A Surf channel list can contain up to fifty channels. You can return to normal viewing by pressing the **Exit** button or pressing the **Surf** button again. Refer to Section 6.2 for creating and customizing your own Surf channel list.

17 Info

Displays station and program information in the banner shown at the top of the screen. To remove the banner, press the button again or wait for 10 seconds. You can select the display mode, short or detailed, by pressing “▲▼”. You can also change the Audio language, when available, by pressing “◀▶”.

18 Help (?)

Shows the on-screen “EZ Help” menu while you are in normal viewing. The “Help (?)” button also serves when you are in an on-screen menu. To see the help description of the selected option in the menu, press and hold the “Help (?)” button.

19 Thumbstick (Menu directional arrows)

Allows you to navigate the on-screen menus and adjust the system settings and preferences, by moving to a menu option with “▲▼◀▶” and selecting the highlighted option with “◉”. If “◉” is pressed while you are in normal viewing, the information banner is displayed.

20 Exit

Clears all on-screen displays and returns to TV viewing from any menu.

21 Component Control Buttons

Provides control for DVD players, VCRs, and similar components. The left and right chapter buttons (L Chap, and R Chap) are used to jump chapter by chapter during DVD playback. The remote control must be programmed for the brand of component being used. For further instructions on remote control programming, please refer to Section 4.3 of this operating guide or the Program Remote section of on-screen help.

4-3. Programming the Remote Control

The HD satellite receiver remote control is a multi-brand or universal remote control that can be programmed to control most remote-controllable components of other manufacturers.

NOTE

The remote control may not control all models of other brands.

1. Test your remote control

To find out whether your remote control can operate a component without programming, turn on the component such as a VCR and press the corresponding mode button (VCR) on the remote control while pointing at the component. Use the **Power** and **CH +/-** buttons to see if the component responds properly. If not, the remote control requires programming.

2. Turn on the component to be programmed. Then press the corresponding mode button on the remote control.

3. Press the **Power** button and the **Mute** button simultaneously. The remote control is now ready to program the code for the component.

4. There are two ways to find the right code of the component.

First, if you press the **CH +/-** buttons repeatedly, the code will change one at a time. Press the **Power** button after each code change. If the right code is found, the device will turn off.

Second, enter the code number using the digit buttons on the remote control. The right code numbers for the corresponding component can be found on the following pages. Again, if the code is correct, the device will turn off.

5. Press the **Exit** button to store the programming code.

6. Test the remote control functions to see if the component responds properly. If not, repeat from step 2.

4. ZENITH HD SATELLITE RECEIVER OPERATION

4-4. Remote Control Codes for Other Components

TV Codes

Brands	Codes	Brands	Codes	Brands	Codes	Brands	Codes
Akai	146	Hitachi	011 163 166	Nikei	043	Siemens	088
Amark	112 143		158 143 004	OnKing	043	Singnature	072
Ampro	167 073		010 012 023	Onwa	043	Sony	070 147 126
Blaupunkt	088		075 001 009	Optonica	019 081		085 139 041
Broksonic	035		041	Panasonic	034 080 092		079
Candle	002 003 004	Inifinity	164		056 164	Soundesign	028 003 043
Capehart	058	Inkel	129	Philco	003 024 056		116
Citizen	002 003 004	JBL	164		059 060 063	Spectricon	112
	043 101 103	J.C Penny	008 030 065		064 164 004	SSS	004 043 116
	143		010 160 004		143 043 127	Super Macy	002
Classic	043		024 143 009	Philips	164 038 070	Sylvania	003 059 060
Concerto	004		156		093 001 003		063 064 164
Contec	039 043 050	Jensen	013		004 143 059		044 160 116
	051	JVC	038 083 145		160		127 140
Coronado	143		034	Pioneer	135 025 023	Tandy	081
Craig	043 054	KEC	043		001 018 116	Tatung	056 062
Crown	043 143	Kloss	002 059		027	Technics	084
Daewoo	004 016 017	KMC	143	Portand	004 143	Techwood	004
	043 044 055	KTV	043 001 143	Proscan	144	Teknika	002 003 004
	071 076 103		154	Proton	116 131 143		024 028 043
	107 111 114	Lodgenet	072		058 171		072 101 143
	117 120 123	Logik	072	Quasar	034 092 056		031 077 103
	125 127 128	Luxman	004	Radio Shack	019 043 047	Telefunken	037 046 086
	136 143	LXI	166 007 015		116 127 143		087
Daytron	116 143		164 160 081			Telerent	072
Dynasty	043		052	RCA	160 161 165	TMK	004 116
Electrohome	007 143				065 156 144	Toshiba	015 138 030
Emerson	028 048 043	Magnavox	164 059 001		001 004 023		007 040 062
	155 005 096		003 060 061		024 056 074		101 051
	047 116 153		063 064 160	Realistic	007 019 043	Totevision	143
	151 001 050		004 143 127		047	Universal	008 009
Fisher	077 057	Marantz	001 164 077	Runco	168 169	Video Concepts	146
Funai	028 043	Matsui	164	Sampo	058 116	Vidtech	004 116
Futuretech	043	Memorex	007 072 116	Samsung	050 089 101	Wards	004 008 009
General Electric	160 144 165	Metz	088		105 113 116		019 028 060
	073 130 001	MGA	004 028 042		127 133 137		061 063 064
	008 009 034		049 077 116		143 160		072 074 116
	056 074 116	Minerva	088	Sanyo	166 007 057		143
	155 091	Mitsubishi	109 024 124		082 020 053	Yamaha	004
Goldstar	102 106 110		001 004 040		021 033 039	York	116
	112 113 116		116 146 028	Scott	028 043 116	Yupiteru	043
	119 122 127		042	Sears	015 030 004	Zenith	072 073 095
	137 143	MTC	101 130 134		007 028 057		157
Hall Mark	116		001 040 016		143 094 160	Zonda	112
			024 056 007		116 082 101		
			019	Sharp	170 081 019		
					028 029 014		
					004 022 143		

4-4. Remote Control Codes for Other Components

VCR Codes

Aiwa	034	Instant Replay	031 033	Panasonic	066 070 083	073sharp	149 031 054
Akai	146 043 046	JCL	031 033		145 133 140	Shintom	024
	124 125 142	J.C Penny	012 013 015		074	Sony	009 056 057
	016		066 040 033	Pentax	013 020 031		058 077 003
Ampro	072		101		033 063		149 052 076
Audio dynamics	012 023	Jensen	043	Philco	031 033 034		031 078
	039 043	JVC	048 043 130		067	Soundesign	034
Broksonic	035		150 050 055	Philips	031 067 034	STS	013
Canon	028 031 033		060 012 031		101 054 033	Sylvania	031 059 033
Capehart	018		033		071		034 067
Craig	033 040 135	Kenwood	014 043 048	Pilot	101	Symphonic	034
Curtis Mathes	031 033 041		039	Pioneer	021 048 013	Tandy	010 034
Daewoo	005 007 010	Lloyd	034	Portland	108	Teac	034 039 043
	064 065 108	LXI	034 101 013	Pulsar	072	Technics	031 033
	110 111 112		014	Quartz	002 014	Teknika	031 019 033
	116 117 119	Magin	040	Quasar	033 066 075		034 101
Daytron	108	Magnavox	067 031 034		145	Thomas	034
DBX	012 023 039		041 033 068	RCA	013 020 033	TMK	006
	043	Marantz	031 067 012		041 062 063	Toshiba	112 131 008
Dynatech	034 053		033 069		107 109 140		047 059 082
Electrohome	059	Marta	101		144 145 147		042 013
Emerson	006 029 035	Matsui	027 030	Realistic	003 008 010	Totevision	040 101
	025 027 034	MEI	031 033		014 031 033	Unitech	040
	036 037 046	Memorex	101 003 010		034 040 053	Video Research	012
	101 129 131		014 031 034		054 101	Video Concepts	012 046 034
	138 017 031		053 072 139	Rico	058		141
Fisher	003 008 009		134 033	Runco	148	Videonsonic	040
	010	MGA	045 046 059	Salora	014	Wards	013 024 031
Funai	034	Minolta	013 020	Samsung	032 040 102		034 040 053
General Electric	031 072 144	Mitubishi	059 061 151		104 105 107		054 003 017
	147 033 063		142 013 020		109 112 113		033 131
	107 109		045 049		115 120 122	Yamaha	012 043 034
Goldstar	012 013 020	MTC	034 040		125		039
	101 106 114			Sansui	022 043 048	Zenith	072 080 056
	123	Multi Tech	024 034		135		048 034 101
Go Video	132 136	NEC	012 023 043	Sanyo	003 010 014		058
Harman Kardon	012 045		048 039		134 007		
Hitachi	004 026 034	Nordmende	043	Scott	017 037 129		
	043 150 063	Optonica	053 054		112 131		
	137 018			Sears	003 008 010		
					013 014 081		
					101 009 020		
					031 042		

DVD Codes

Code	Supported Brands
960	Zenith 2300
961	Toshiba
962	Sony
963	Pioneer
964	Mitsubishi
965	JVC

4. ZENITH HD SATELLITE RECEIVER OPERATION

4-4. Remote Control Codes for Other Components

AUX (AUDIO)

Goldstar	005	Hitachi	010	JVC	006 039 049	KENWOOD	001 013 029
Luxman	017	Marantz	002 021 028		050		031 044
NAD	014		030 032 035	ONKYO	008 009 025	Optimus	011 013 022
Panasonic	003 015 036	Pioneer	007 016 020		040 041	Quasar	003 036
	046		023 024 026	Sharp	013 029 043	Sherwood	021 019
RCA	004		033 037 047		045	Sony	027 034 038
Toshia	042	Victor	006 039				048 053

AUX (CD)

Adc	104	KENWOOD	105 110 113	Optimus	100 107 110	Sharp	110 141 150
Aiwa	149 178 189		118 144 154		124 139 140		181 200 204
	202 219		155 198 200		145 146 162		210 150 217
Akai	134 165 200		216 217		164 165 170	Sherwood	102 115 116
Denon	101 190 221	Luxman	108 123 153	Panasonic	106 151 176		128 141 193
	222 223		173		184 203 219	Sony	100 142 168
Emerson	133 136 152	Magnavox	127 135 172		233		174 182 183
	166 175		179 180	Philips	127 135 195		192 308 234
Marantz	002 021 028	Mcs	111 147 156		199 237		235 236
	030 032 035		169	Pioneer	107 124 167	Technics	106 148 151
Fisher	113 122 138	Mitsubishi	120 179 229		171 179 187		176 184 203
	140 168		230 231		191 205 206		214 218
GE	209	Onkyo	125 126 130	Quasar	207	Teac	103 112 132
Hitachi	133 166		131 213 215	Radio shack	106 176		141 160 161
JVC	117 196 227		232	Sanyo	186 188		177 185 161
	228				121 140 158	Yamaha	197 201
					168		109 119 137
				Sears	147		143 194 211

5. INITIAL SETUP

CAUTION: Check your TV screen to determine the display format required and place the switch in that position before turning the receiver on. The format switch on the rear of the receiver must be in the correct position for your display. The on screen display or the picture may not appear if the wrong mode is selected.

When you turn on the HD Satellite Receiver for the first time, you will be asked if you want to set up DIRECTV® Programming.

To proceed with this process, follow the instructions on the screen. You should complete all the answers once this initial setup process starts.

This setup process will be displayed only once. Future setting changes can be made using the Menu system.

This means that you can change all the settings DIRECTV Initial Setup section of the main menu.

If you have chosen to subscribe to DIRECTV, you should contact DIRECTV at 1-800-DIRECTV(or 1-800-246-3288) and order programming.

When you order programming, you need to know your access card number. To get this number, press MENU on the remote control, then select SYSTEM on the Menu. Select System Test on the screen, and you will see the Access Card Identifier. Another way to find the number is to by taking out the access card and referring to the number written on it.



6. BASIC OPERATION

6-1. Viewing the Channel Banner

The Channel Banner appears whenever you tune to a new channel or press the **Info** button on the remote control while viewing a program. It displays channel and program information in the banner shown at the top of the screen. When the Channel Banner is displayed, pressing “▲▼” toggles between extended and regular information banners. To remove the banner, press **Info** again or wait for 10 seconds.

The icons in the Channel Banner represent the status or availability of important features. The icons will be highlighted when the feature is active or available. The information available on the Channel Banner is described below.



6-1. Viewing the Channel Banner

Input Source Icon

Indicates from which the current program signal is being received. The IRD can receive a signal from ANT, ANT/Digital, CABLE, CABLE/Digital or DIRECTV.

Lock Icon

Indicates that the lock system is activated.

Alternate Audio

DIRECTV® and ATSC channels sometimes provide multiple audio tracks, usually in different language. When multiple audio tracks are available, the Alternate Audio icon changes its appearance to indicate that you can select one of those audios by pressing “◀▶” buttons.

Mail Icon

Indicates that your HD satellite receiver has electronic mail messages from DIRECTV. The mail icon will appear in the channel banner to indicate that a new mail message has arrived or there are unread messages in the box.

HD Icon

Indicates that the current program is in the HD format.

DD Icon

Indicates that the currently selected audio track is Dolby Digital.

CC Icon

Indicates that the current program provides the closed caption service.

Channel Logo

Displays the logo of the current channel. If a channel logo is not available, the channel name will be displayed instead.

Channel Number

Displays the current channel number.

Start and End Time

Displays the start time and end time of the current program.

Rating

Displays the rating of the current program.

Date

Displays the production date of the current program.

Program Description

Displays a brief description of the current program (if provided by DIRECTV).

Category

Displays the genre of the current program.

6. BASIC OPERATION

6-2. Channel Surfing

The surf list appears on the TV screen when you press the **Surf** button on the remote control. It enables you to surf up to 50 favorite channels that were chosen in the Edit Channel section of the Setup menu. The surf list consists of the channel logos or channel numbers. If the logo of a certain channel is not available, the channel number is displayed instead.

You can easily move the highlight on the surf list using “▲▼◀▶” on the thumbstick of the remote control. The next page is accessible by using **Pg Up/Dn** button on the remote. You can tune to a favorite channel by pressing “⊙”. Or the **Exit** button on the remote will clear the surf list and take you back to the current channel.

You are also able to add or delete the logo of a channel on the surf list by pressing the **Info** button on the remote. A dialog box will ask what you want to do with the highlighted logo area: you can replace the highlighted logo area with the current channel, or delete it.



6-3. Subscription to DIRECTV® Programming and ANT/CABLE-Only operation

The Zenith HD Satellite Receiver is designed to receive signals from DIRECTV, ANT and /or CABLE. If you are a DIRECTV customer, you can enjoy all programming provided by DIRECTV. You can also receive the analog and digital over-the-air broadcasts, with the benefit of the Advanced Programming Guide (APG) which is an integrated electronic program guide. The APG provides program listings and information on analog and digital channels from over-the-air local stations as well as DIRECTV® channels. You can easily navigate and tune to hundreds of channels from various signal sources with the APG. If you don't subscribe to DIRECTV® programming, however, the function of your HD receiver will be limited to receiving signals only from ANT and/or CABLE. You can still enjoy HD services provided by over-the-air digital broadcast along with the conventional analog broadcast. Without the DIRECTV® service, however, no electronic program guide is available.

7. ADVANCED PROGRAM GUIDE™

7-1. About the Advanced Program Guide™

The Advanced Program Guide™, DIRECTV newly deployed electronic program guide system, contains schedule and program information for all DIRECTV® channels. The APG also provides local over-the-air channels information including both conventional analog and digital channels. By utilizing the APG, the Zenith HD Satellite Receiver stores and presents a comprehensive three-day program lists covering hundreds of channels

Helping you to find a program easily and conveniently, the APG allows you to view schedule and descriptive program information for the channels. The receiver offers five different channel lists: ALL, CUSTOM, SURF, MOVIES and SPORTS. You may edit the CUSTOM and SURF channel lists to customize and design your favorite channels, respectively. In addition, You can easily find specific programs by using the CATEGORY search of KEYWORD search functions. An explanation of each channel list is described in Section 7-2.

You can bring up the APG in two ways and exit from it in three ways.

To bring up the APG:

- Press the **Guide** button on your remote control.
- Press the **Menu** button on the remote control and select the DIRECTV menu. Several options will appear. Choose the Guide option (menu->DIRECTV->Guide)

To exit the APG:

- Press the **Exit** button to return to the last channel you were tuned to.
- Press the **Guide** button on the remote control twice when a program or channel is highlighted. The first press moves the highlight to the Guide menu at the far left. Pressing the button a second time makes the APG disappear.
- When any currently broadcasted program is highlighted, pressing "  " on the thumbstick will make the guide screen disappear and tune to that channel.

7-2. Layout of the Advanced Program Guide™ Screen

The on-screen guide maintains five different channel lists, each of which shows you only those channels and programs that belong to that channel list. The meaning and generation of each channel list is described below

All Shows program listings for all channels that you are eligible to access. They include DIRECTV® channels that your dish antenna can receive and you subscribe to, and over-the-air channels that you have selected to add into the channel list during the initial setup procedure.

Custom Shows the program listings that belong to the CUSTOM channel list. You can customize the CUSTOM channel list. by hiding channels from the All channel list that you do not wish to view.

Surf Shows program listings only for those channels on the SURF channel list. You can generate a SURF channel list, which is a short list of channels you tune to most frequently, by setting a surf icon to the channels from the menu sequence menu->SETUP->Surf List/Ch. Edit.

Movies Lists only movie programs from channels in the All channel list that have acceptable ratings. The Zenith HD Satellite Receiver generates the list automatically based on the category information of each program identified in the APG.

Sports Shows only sports programs. The Zenith HD Satellite Receiver generates the list automatically based on the category information of each program identified in the APG.

The guide screen also provides two search menus:

Category Searches for programs that belong to a given category. The Zenith HD Satellite Receiver first shows you currently applicable categories and allows you to search for programs in that category.

Keyword Searches for programs that have or are related to a specific keyword. You can choose a keyword for program titles or credit titles (for example, actor/actress, director, writer, awards, etc.).

When accessing an on-screen guide, you will always return to the last guide menu, one of the five channel lists or one of the two search menus, that you have turned to.

7. ADVANCED PROGRAM GUIDE™

7-3. Moving through the Advanced Program Guide™

The Advanced Program Guide™ is operated based on a simple and straightforward “Highlight and Select” process.

1. Use “▲▼◀▶” on the thumbstick of your remote control to navigate the guide screen.
2. Press “⊙” on the thumbstick to select or execute the highlighted menu or function.

The on-screen guide shows you program listings for seven channels within a and a half hour-time slot. In order to view a list of future programs or other channels, you may continuously press “▲▼◀▶” on the thumbstick to scroll horizontally or vertically. This may take a while to reach a specific channel or program, if the channel or program is listed far from the currently highlighted program. The Advanced Program Guide™ thus offers you shortcuts to minimize your effort in navigating and time slots.

Line Scrolling

You can reach other time slots or channels that are currently hidden from the screen using the arrow buttons “▲▼◀▶” on the thumbstick. Move horizontally to reach other time slots and move vertically to reach other channels.

Page Scrolling

You can move faster vertically by scrolling page by page with the **Pg Up/Dn** buttons on the remote control. Each button stroke scrolls one page up or down.

Date Scrolling

You can scroll time slot day-by-day using the **CC/Date** button on the remote control. Alternatively, you can move the highlight to the Date Change box and change the date to jump to the time slot of that day.

Direct Jumping

You can quickly jump to a page that contains a specific channel by directly entering the channel number using the digit buttons “0-9” on the remote control.

Pressing “⊙” on the thumbstick following the digit button strokes will move to the channel immediately.

NOTE

Press the **Guide** button to return immediately to the guide menus, the leftmost column of the guide screen. This is very useful when the highlight is located far from the current time and you want to return to the guide menus.

7-4. Selecting a Program

The top region of the guide screen displays the schedule and program information of the currently highlighted program. You can also see other detailed information about the program by pressing the **Info** button.

When you select the highlighted program by pressing “**⊙**”, what happens or appears next depends on whether the highlighted program is currently on-air or scheduled in the future, and **whether or not it is a Pay Per View program.**

Current / Free-of-Charge

If the selected program is a current free-of-charge program, you will directly tune to the program.

Future / Free-of-charge

If the selected program is scheduled in the future and is a free-of-charge program, you will be offered a dialog box that enables you to reserve this program for watching. If you select Remind in the dialog box, this program is put on the Remind List and you will be reminded by a message at the top-left corner of the screen 10 seconds before its airing time.

Current / Pay Per View

If the selected program is a current Pay Per View program, you will be asked if you want to purchase this program. You can directly tune to and view the program after confirming the purchase.

Future / Pay Per View

If the selected program is a Pay Per View program scheduled in the future, you will also be asked if you want to purchase this program. Once you confirm the purchase, this program is put on the Future Purchase list. You can view the Future Purchase list from the menu sequence Menu → DIRECTV → Future Purchase and cancel any purchase on the list anytime before broadcasting.

A continuous connection to a land-based phone line is required to perform this function with your remote control. An additional fee applies to all Pay Per View phone-in orders.

7. ADVANCED PROGRAM GUIDE™

7-5. Getting More Information

Pressing the **Info** button will display available additional information about the highlighted program. It includes actor and role relationships, original material, production studio, the date on which the program was first shown, and so on.

To display program details:

1. Move the highlight to a desired program by using “▲▼◀▶”, **Pg Up**, **Pg Dn** or **CC/Date** on the remote control.
2. Press the **Info** button on the remote control to display the available additional information.
3. If you want to check any other broadcasting schedules for this same program, move the highlight to the “Other Times” option, located on the right side of the additional information box, and press “⊙”.
4. To return to the previous guide screen, press “◀” or the **Info** button again.



NOTE

To get channel information, press “⊙” when the channel number, the second column from the left of the screen, is highlighted. The top region of the guide screen displays the Channel name and description about the channel, if available.



7-6. Referring to EZ Help

Your basic understanding of certain features and terminology used in the APG will help you to fully enjoy the functionality of the Zenith HD Satellite Receiver. The receiver's unique feature called 'EZ Help' serves as an on-line snapshot user's manual.

If you want to find out what the highlighted menu item is for and how it works while you are in the APG, just press and hold the **"Help (?)"** button on your remote control. A quick help screen with brief and focused descriptions will appear at the right side of the screen. EZ Help also provides operation tips at the bottom of every page.

Once you release the **"Help (?)"** button, the help display will disappear instantly.

If you press the **"Help (?)"** button while you are viewing a program, it will guide you to the EZ Help feature, which is an on-line version of this Operating guide.

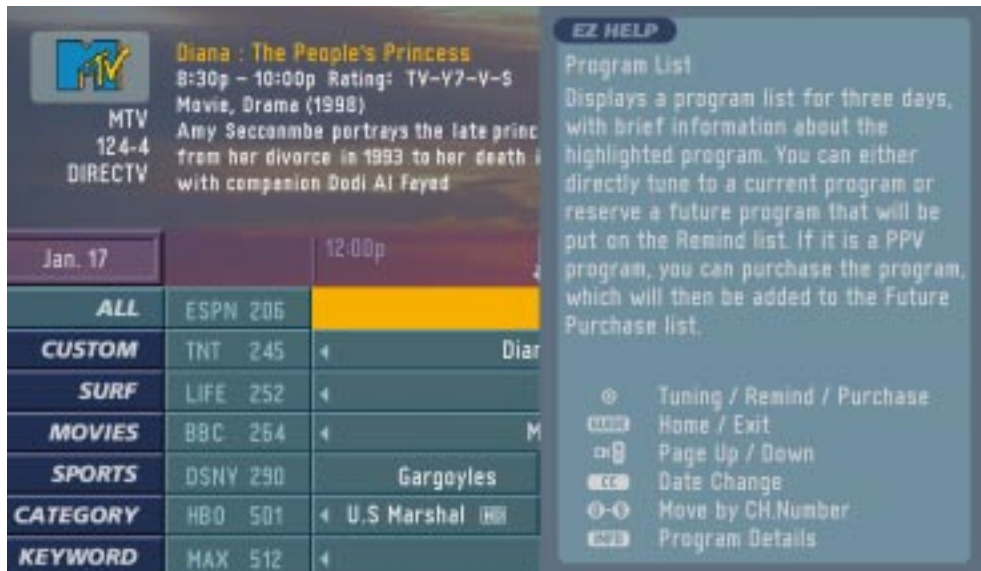

7. ADVANCED PROGRAM GUIDE™

7-7. Making a Remind List for Future Viewing

If you want to view a program scheduled in the future, you can put that program on the Remind List so that a reminder message will appear right before the program starts.

To schedule a future viewing :

1. Move the highlight to a future program you want to watch by using “▲▼◀▶” on the thumbstick on the remote control.
2. Press “⊙”, A dialog box will appear for your information.
3. Move the highlight to the Remind option in the dialog box and press “⊙” to confirm. The program name will be preceded by the mark (√). If you want to cancel any reservation, execute the menu sequence menu->DIRECTV->Remind List and press “⊙” when the highlight is on the reservation.

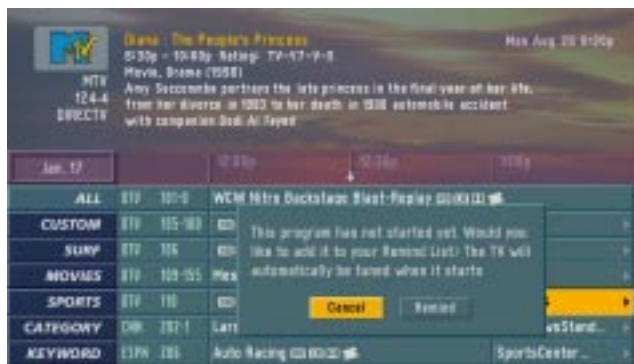

NOTE

A reminder message will appear at the top-left corner of the guide screen 10 seconds before the reserved program actually starts. The receiver will automatically tune to the program if you do not cancel it.

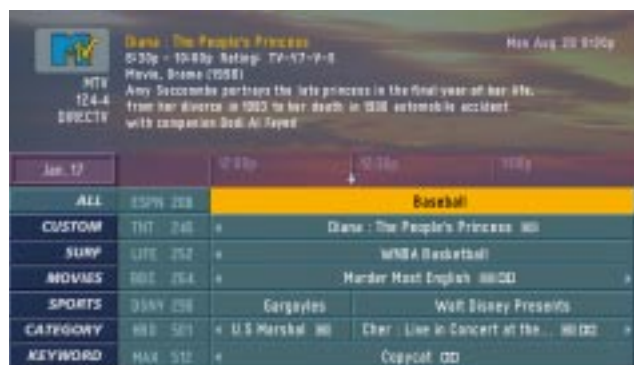

7-8. Purchasing Pay Per View Programs

If you subscribe to DIRECTV® programming, you may preview Pay Per View movies on channel 2000, the DIRECTV promo channel, determine if you would like to purchase them.

To purchase PPV programs:

1. Press “**⊙**” on the thumbstick on the remote control to select the PPV program.
The dialog box will appear to ask you whether you want to purchase or not.
Selecting the “Others” button will show you other time schedules for the program.
2. Move the highlight to the right to “Buy” in the dialog box and press “**⊙**”.
Another pop-up box will be displayed to verify your purchase.
3. If you wish to receive the program, move may the highlight to the right again to “Record” in the dialog box and press “**⊙**”.
The program can be recorded via A/V out 1 or 2.



7. ADVANCED PROGRAM GUIDE™

7-9. Searching Programs by Category

You can search for specific programs by their categories. The category information of each program is provided by the APG so that you can choose one of them to search for matching programs. You can also set a search range to One Day or Three Days, (within 24 hours and 72 hours from now, respectively). In the search result one program may have multiple showings in different channels and/or in different time slots.

To search programs by Category :

1. Highlight the CATEGORY in the guide menu. You will see currently applicable categories in a two-level structure. The Category Search screen consists of three columns: the first column from the left shows the core categories, the middle column shows the sub-categories that belong to the same core category, and the rightmost column lists programs resulting from a category search.
2. Move the highlight to a core category. You will see sub-categories belonging to that core category in the middle column. By moving the highlight around and viewing available categories, you can select any of them for searching regardless of core or sub-categories.
3. The program resulting from the search will be listed in the rightmost column. The highlight goes to the top program on the list and its schedule and program information will be displayed at the top region of the guide screen. You can see schedule and program information on each program by moving the highlight using "▲▼". If you choose a program and press "⊙", you will be asked to select one of the available showings of that program. Once a choice is made, ALL channel listings will replace the Category Search screen and the highlight will go to the specified showing.

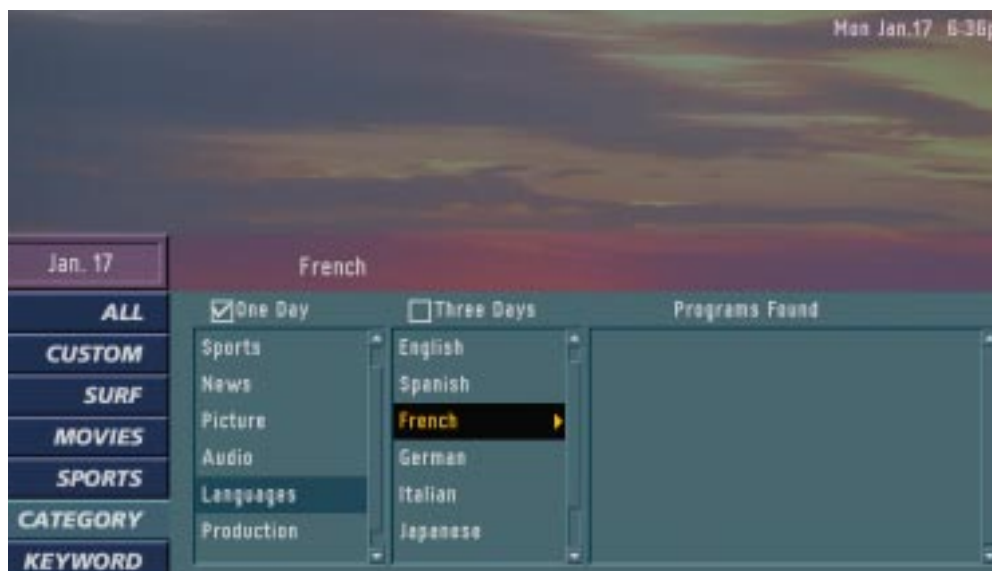

7-10. Searching Programs by Keyword

You can also search for programs by keyword that include the keyword in their program titles or credit titles such as actor/actress name, director name, etc.

To search programs by keyword:

1. Move the highlight to the KEYWORD in the guide menu. The Keyword Search screen will appear on the right side of the guide menu.
2. Move the highlight to the right and enter a word using the screen keyboard. Highlight a letter first and press "⊙" to type it in.
3. When a word is completed or even when only a partial word is typed in, you may, move the highlight to the Search option located on the bottom of the screen keyboard and press "⊙" to execute searching.
4. The receiver first searches for candidate keywords that include the word or the partial word you entered. You can select one of the candidate keywords to search for programs that have or are related to the selected keyword.
5. The programs resulting from the search will be listed in the rightmost column. The highlight goes to the top program on the list. Its schedule and program information will be displayed at the top region of the guide screen. You can see schedule and program information on each program by moving the highlight using "▲▼". If you choose a program and press "⊙", you will be asked to select one of available showings of that program. Once a choice is made, ALL channel listings will replace the Keyword Search screen and the highlight will go to the specified showing.



8. CUSTOMIZATION

8-1. The Structure of the On-screen Menu

In this menu system, there are several hierarchies to customize the settings provided. Most menus consist of three levels to set up the options, but some menus go to and require further levels to be set. If you press the **Menu** button, only the first level of the menu system will appear at the left side of the TV screen. The second and third level will be displayed by pressing "⊙" on the thumbstick. If a menu has more than three levels, the pop-up dialogue box will be displayed as the fourth or fifth level. For navigating the hierarchical menu levels, the visual cue, "⊙" or "▶" is shown on the right side of the menu label to help you go to the next level.

To bring up and exit the Menu:

Press the **Menu** button on the remote control to bring up the menu. A second press of the Menu button or a press of the **Exit** button will take you back to TV viewing.

To go to the next level:

Press "⊙" or "▶" on the thumbstick of the remote control.

To go back to the previous level:

Press "◀" on the thumbstick of the remote control.



8-2. The Hierarchy of the On -Screen Menu

DIRECTV	Guide Remind List Future Purchase Purchase List Mail List Initial Setup
SETUP	EZ Channel Scan Manual Ch. Add Surf List/Ch. Edit EZ Hook-up Clock
AUDIO	Digital Output Audio Mode Audio Variable Audio Language
PREFERENCE	TV Aspect Ratio Closed Caption Output Channel Out to TV Digital TV Input EZ Demo
LOCK	Lock System Block Channel Movie Rating TV Rating – Children TV Rating – General Spending Limit
SYSTEM	System Test Replace Card Software Info Feature List CA Menu

8. CUSTOMIZATION

8-3. Previewing the Remind List

The Remind List shows the programs you have reserved in the Guide menu. You may cancel any program in the list by selecting the program. A pop-up screen will ask if you want to cancel it.

To cancel a program in the Remind List:

1. Press the **Menu** button on the Remote Control to display the on-screen menu.
2. Select the DIRECTV menu by pressing "⊙" on the thumbstick of the remote control.
3. Scroll down to Remind List by using "▲▼" on the thumbstick.
4. Move the highlight to the right with "▶" on the thumbstick to select a program from the list.
5. Press "⊙" and the pop-up dialogue box will be displayed.
6. Select "Yes" in the pop-up box if you want to cancel, then the highlight will return to the list.
7. Press "◀" to return to the previous level or press the **Exit** button on the remote control if you want to return to TV viewing.

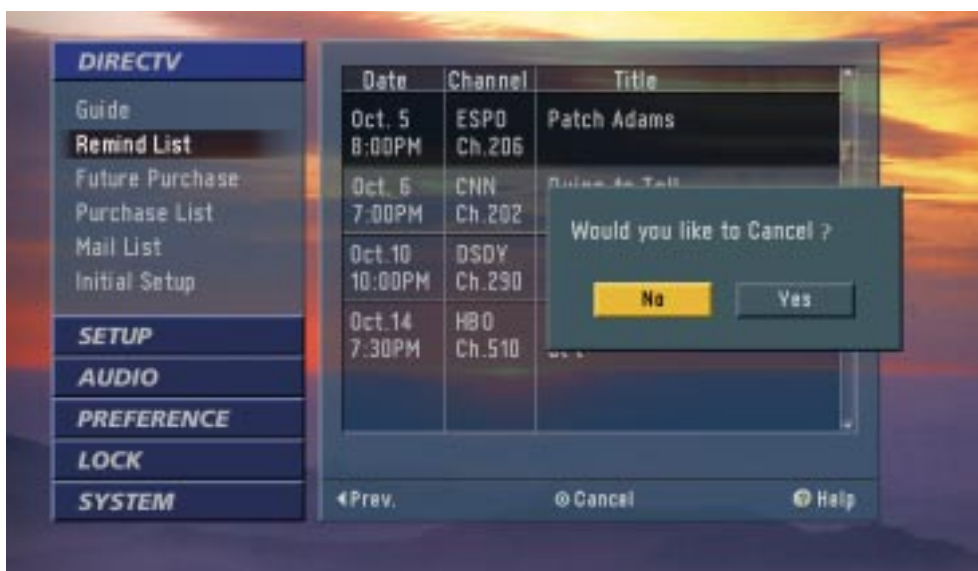

8-4. Managing Program Purchases

New Purchase

Allows you to review upcoming DIRECTV® Pay Per View purchases. You may cancel any programs that have not been viewed by selecting the program. A pop-up screen will ask you if you want to cancel the program.

To cancel a newly purchased program :

1. Press the **Menu** button on the Remote Control to display the on-screen menu.
2. Select the DIRECTV menu by pressing “**⊙**” on the thumbstick of the remote control.
3. Scroll down to New Purchase by using “**▲▼**” on the thumbstick.
4. Move the highlight to the right with “**▶**” on the thumbstick to select a program from the list.
5. Press “**⊙**” and the pop-up dialogue box will be displayed.
6. Select “Yes” in the pop-up box if you want to cancel, then the highlight will return to the list.
7. Press “**◀**” to return to the previous level or press the **Exit** button on the remote control if you want to return to TV viewing.



8. CUSTOMIZATION

8-4. Managing Program Purchases

Purchase List

Shows you a list of past DIRECTV® Pay Per View purchases. You can see each charge of the PPV programs you purchased and viewed.

To review programs in the Purchase List:

1. Press the **Menu** button on the Remote Control to display the on-screen menu.
2. Select the DIRECTV menu by pressing "⊙" on the thumbstick of the remote control.
3. Scroll down to the Purchase List by using "▲▼" on the thumbstick.
4. Move the highlight to the right with "▶" on the thumbstick to scroll the purchase list.
5. Press "◀" to return to the previous level or press the **Exit** button on the remote control to return to TV viewing.



NOTE

CAM: Conditional Access Module, usually referred to as the access card. A removable, electronic subassembly provides conditional access control of the subscriber terminal.

CAM Slot No: The CAM slot number indicates which slot the purchase occupied. A customer service representative may use these slot numbers to help resolve billing issues.

8-5. Checking the Mail Box

The Mail Box keeps the messages that are sent from DIRECTV. For example, you may receive a message requesting your attention to a new service or special program offering.

To check the Mail Box:

1. Press the **Menu** button on the Remote Control to display the on-screen menu.
2. Select the DIRECTV menu by pressing "⊙" on the thumbstick of the remote control .
3. Scroll down to the Mail List option by using "▲ ▼" on the thumbstick.
4. Move the highlight to the right with "▶" on the thumbstick to select a mail item from the list.
5. Press "⊙" and the full text of the mail will be displayed in the pop-up dialogue box.
6. Select "Delete" on the pop-up box if you want to delete it.
7. Press "▶" to return to the previous level or press the **Exit** button on the remote control if you want to return to TV viewing.



NOTE

The E-mail icon will be displayed in the Channel Banner only when at least one unread message is in the mail buffer.

8. CUSTOMIZATION

8-6. Initializing the System

About Initial Setup

Your Zenith HD Satellite Receiver is capable of receiving three types of signals; over-the-air or terrestrial and DIRECTV programming (if you are a DIRECTV customer). Initial Setup lets you initialize your system to function properly with your dish antenna.

Select Dish

Lets you select the correct type among three different types available; Round Dish for Satellite Network A only, Oval Dish for Satellite Networks A and B, or Oval Dish for Satellite Networks A, B, and C. For advice on selecting a dish that will provide the services that you desire, contact DIRECTV (1-800-DIRECTV) or your local Zenith/DIRECTV retail expert. If you already have a dish, refer to its user's guide to determine its type.

To receive HD programming, you should select the Oval dish type(Oval dish(Sat A,B) or Oval dish(Sat A, B, C)) in the Select Dish menu.

Auto Detection is used to enable access to additional DIRECTV satellites after the dish is pointed. You must select No Dish if you have no dish, and you cannot proceed further in this menu.

To select dish:

1. Press the **Menu** button on the Remote Control to display the on-screen menu.
2. Select the DIRECTV menu by pressing "⊙" on the thumbstick on the remote control .
3. Scroll down to Initial Setup by using "▲▼" on the thumbstick.
4. Move the highlight to the right with "▶" on the thumbstick to choose Select Dish.
5. Press "⊙" and the pop-up dialogue box will be displayed. Select your dish type.
6. Select your dish type by using "▲▼" and press "⊙".
The highlight will return to the previous screen.
7. Select Your Location by using "▲▼" for the next step of the initial setup.



NOTE

Although the initial setup is a sequential process from Select Dish to Channel Setup, each menu can be accessed independently.

8-6. Initializing the System

Your Location

Provides the coordinates of elevation, azimuth, and tilt based upon your zip code. Elevation is the up/down angle of the dish. Azimuth is the side-to-side direction, while tilt is the circular rotation of the dish itself around the pointing axis. Full instructions for the installation of your dish are provided with your satellite dish antenna.

To enter your location:

1. Press the **Menu** button on the Remote Control to display the on-screen menu.
2. Select the DIRECTV menu by pressing "⊙" on the thumbstick on the remote control.
3. Scroll down to Initial Setup by using "▲▼" on the thumbstick.
4. Move the highlight to the right with "▶" on the thumbstick to select Your Location.
5. Press "⊙" and the pop-up dialogue box will be displayed.
6. Enter your zip code by using the digit buttons on the remote control.
7. Press "⊙" to show the elevation, azimuth and tilt.
Point your dish properly with the azimuth, elevation and tilt values given.
8. Press "⊙" to return to the Your Location menu.
9. Select Signal Strength by using "▲▼" for the next step of initial setup.



NOTE

Although the initial setup is a sequential process from Select Dish to Channel Setup, each menu can be accessed independently.

8. CUSTOMIZATION

8-6. Initializing the System

Signal Strength

Shows you up to three signal strength bars for Satellite Networks A, B, and C, in order to help you adjust the dish to the correct position with the elevation, azimuth, and tilt values obtained from the Your Location menu. While the maximum signal strength is 100, there will be no apparent difference in picture quality between signal strengths of 60 to 85. The higher the signal, the less likely you are to experience degradation when it rains or snows.

A transponder is a receiver/transmitter on the satellite. It receives signals from DIRECTV and retransmits them to your dish. The Zenith HD Satellite Receiver is capable of displaying the signal strength of each transponder by using the following method.

To see the signal strength:

1. Press the **Menu** button on the Remote Control to display the on-screen menu.
2. Select the DIRECTV menu by pressing “**⊙**” on the thumbstick on the remote control.
3. Scroll down to Initial Setup by using “**▲▼**” on the thumbstick.
4. Move the highlight to the right with “**▶**” on the thumbstick to select Signal Strength.
5. Press “**⊙**” and the pop-up dialogue box will be displayed.
6. Move the highlight to select the desired transponder.
7. Press “**⊙**” to return to Signal Strength.
8. Select Channel Setup by using “**▲▼**” for the next step of initial setup.



NOTE

Although the initial setup is a sequential process from Select Dish to Channel Setup, each menu can be accessed independently.

8-6. Initializing the System

Channel Setup

Searches for all channels available in a selected local area. You can select two distinct areas by Zip code to view the channels being broadcast from both areas. This is useful if you live between two major broadcast centers and are capable of receiving signals from both. After this Channel Setup process, the channel list will be created.

To scan the channels from the satellites:

1. Press the **Menu** button on the Remote Control to display the on-screen menu.
2. Select the DIRECTV menu by pressing “**⊙**” on the thumbstick of the remote control.
3. Scroll down to Initial Setup by using “**▲▼**” on the thumbstick.
4. Move the highlight to the right with “**▶**” on the thumbstick to select Channel Setup.
5. Press “**⊙**” and the pop-up dialogue box will be displayed to ask if you want to add local channels to DIRECTV channels. If you select only DIRECTV channels, you don’t need to do the following process (6-10).
6. Press “**⊙**” if your zip code is correct for the primary local channels. The channel search progress will be shown.
7. If the zip code is missing or incorrect, select the zip code for your city by using “**▲▼**” and pressing “**⊙**” on the thumbstick.
8. Select “Yes” in the pop-up box that asks you if you want to add the secondary local channels.
9. Enter the secondary zip code by using the digit buttons on the remote control.
10. Repeat from 6 to 7.
11. Press “**▶**” to return to the previous level or press the **Exit** button on the remote control if you want to return to TV viewing.



NOTE

Although the initial setup is a sequential process from Select Dish to Channel Setup, each menu can be accessed independently.

8. CUSTOMIZATION

8-7. Managing Channels

EZ Channel Scan (Channel Search)

Automatically finds all channels (both analog and digital) available through the antenna and cable inputs, and stores all the active channels in the channel list. Inactive or weak channels may not appear in the list. In that case, add missing channels manually in the Manual Ch. Add menu. The channel list created here can be shown in the Edit Channel menu.

To scan the channels with the antenna:

1. Press the **Menu** button on the Remote Control to display the on-screen menu.
2. Scroll down by using "▲▼" on the thumbstick on the remote control.
3. Select the Setup menu by pressing "⊙" on the thumbstick.
4. EZ Channel Scan will be automatically highlighted.
5. Move the highlight to the right with "▶" on the thumbstick to select "Start" .
6. Press "⊙" and the moving yellow bar will indicate the progress scanning the channels. When the scanning process begins, "Start" will change to "Next". If you press "Next", the scanning of the Antenna signal source will be ignored and the scanning of the next signal source (cable) will proceed. Next the digital signals will be scanned.
7. When the scanning is completed, the highlight will return to the previous level.
8. Press the **Exit** button on the remote control if you want to return to TV viewing.



8-7. Managing Channels

Manual Ch. Add

Manually adds a channel to your channel list without rescanning all the channels again. EZ Channel Scan may not pick up every channel that is available on Air and Cable. Therefore, it may be necessary for you to add channels manually using this feature. You must enter the RF channel number to add the desired channel to the channel map.

To add the channels missed in your channel list:

1. Press the **Menu** button on the Remote Control to display the on-screen menu.
2. Scroll down by using “▲▼” on the thumbstick on the remote control.
3. Select the Setup menu by pressing “⊙” on the thumbstick.
4. Scroll down to Manual Channel Add by using “▲▼” on the thumbstick.
5. Move the highlight to the right with “▶” on the thumbstick in the channel add box.
6. Enter the channel number desired by using the digit buttons on the remote control.
7. Press “⊙” and the pop-up box of a result will be displayed.
8. Press the **Exit** button on the remote control to return to TV viewing.



8. CUSTOMIZATION

8-7. Managing Channels

Edit Channel

The default channel list is made in the EZ Channel Scan menu. Edit Channel allows you to create two other types of channel lists; custom list and surf list. A custom list can be created by toggling each channel on or off with "⊙". Once a channel is highlighted, you will be able to see whether the channel is currently shown or hidden by referring to the small window at the top-left corner of the screen.

To create your own surf list, with up to 50 favorite channels, refer to the bottom-left corner of the screen. Then press the **Surf** button on the remote control when a channel is highlighted.

To edit the channel list:

1. Press the **Menu** button on the Remote Control to display the on-screen menu.
2. Scroll down by using "▲▼" on the thumbstick on the remote control.
3. Select the Setup menu by pressing "⊙" on the thumbstick.
4. Scroll down to Surf List/Ch Edit by using "▲▼" on the thumbstick .
5. Press "▶" on the thumbstick to display the channel editing menu.

To create a custom list:

1. Use "▲▼◀▶" to move the highlight on the channel editing menu.
2. Choose "Shown" or "Hidden" by using "⊙" on the thumbstick.
The screen shown at the top left will indicate if the highlighted channel is shown or hidden.

To create a surf list:

1. Use "▲▼◀▶" to move the highlight on the channel editing menu.
2. Choose "Surf" or "No Surf" by using the **Surf** button on the remote control.
The surf list shown at the bottom left will indicate if the highlighted channel is shown or hidden.

6. Press the **Menu** button to return to the previous screen or press the **Exit** button on the remote control to return to TV viewing.

NOTE

Use the "Show All" button to show all the channels again.
Use the "Hide All" button to hide all the channels.
This will be especially useful when creating a short custom list.

8-7. Managing Channels



8. CUSTOMIZATION

8.8 EZ Hook Up

Graphically depicts possible connection schemes on the HD satellite receiver to your dish antenna and other components. Since the connection that is best for you depends on your components, keep in mind that an alternative connection is also possible.

To see EZ Hook-up:

1. Press the **Menu** button on the Remote Control to display the on-screen menu.
2. Scroll down by using “▲▼” on the thumbstick on the remote control.
3. Select the Setup menu by pressing “⊙” on the thumbstick.
4. Scroll down to EZ Hook-up by using “▲▼” on the thumbstick .
5. Press “▶” on the thumbstick to display the EZ Hook- up menu.
The seven possible hook-up connections will be shown.
6. Scroll up and down the hook-up figure options shown to determine the correct connections for your system.
7. Press the **Menu** button to return to the previous screen or press the **Exit** button on the remote control to return to TV viewing.

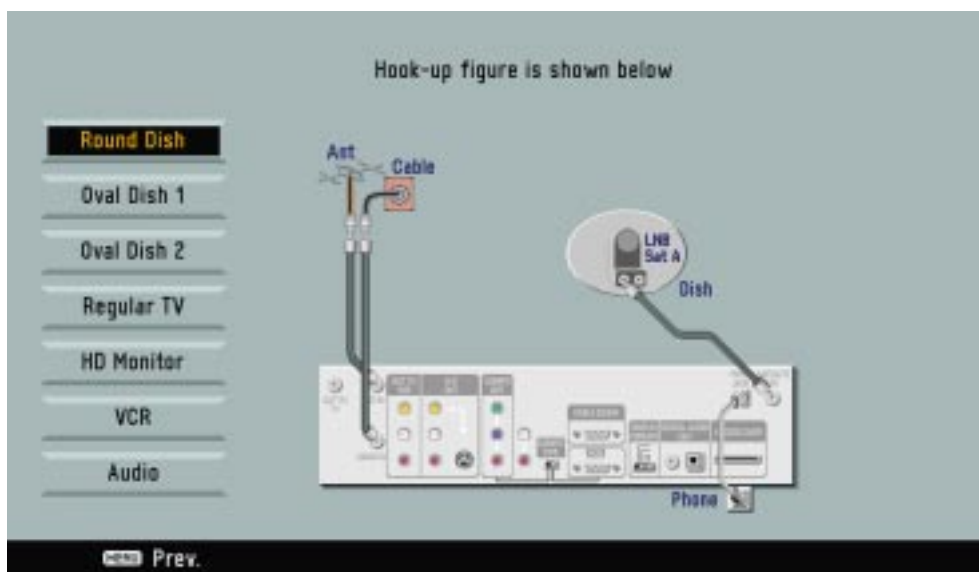

8-9. Setting the Clock

Clock (Auto)

Enables adjustment of the time zone and activation of daylight savings time. Normally, your clock is set using signals transmitted by DIRECTV.

To set auto clock:

1. Press the **Menu** button on the Remote Control to display the on-screen menu.
2. Scroll down by using "▲▼" on the thumbstick on the remote control.
3. Select the Setup menu by pressing "⊙" on the thumbstick.
4. Scroll down to Clock by using "▲▼" on the thumbstick .
5. Move the highlight to the right with "▶" on the thumbstick to Time Zone.
6. Select your time zone between Eastern and Hawaii by pressing "▶" continuously.
7. Scroll down to Daylight Saving and press "▶" to switch daylight saving on or off.
8. If you want to reset the clock, scroll down again to "Reset" and press "⊙".
The highlight will return to the previous level.
9. Press the **Exit** button on the remote control to return to TV viewing.



8. CUSTOMIZATION

8-9. Setting the Clock

Clock (Manual)

Enables you to set the time manually in the ANT/CABLE Only Operation.

To set manual clock:

1. Press the **Menu** button on the Remote Control to display the on-screen menu.
2. Scroll down by using "▲▼" on the thumbstick on the remote control.
3. Select the Setup menu by pressing "⊙" on the thumbstick.
4. Scroll down to Clock by using "▲▼" on the thumbstick .
5. Move the highlight to the right with "▶" on the thumbstick in the entry box by using "▶".
6. Use "▲▼" to move the highlight in the the entry boxes.
7. Enter the number by using the digit buttons on the remote control.
8. Press "◀" to return to the previous screen or
press the **Exit** button on the remote control to return to TV viewing.



8-10. Setting the Audio

Setting Digital Output

If you are using an external audio system that supports Dolby Digital, select Dolby Digital audio mode. If you are using an external audio system that has a PCM only decoder, select PCM (Digital). If you are not using an external audio system, select OFF.

 An external Digital Output other than Dolby Digital and PCM may create a high noise and cause damage.

To set the digital audio mode:

1. Press the **Menu** button on the Remote Control to display the on-screen menu.
2. Scroll down by using “▲▼” on the thumbstick on the remote control.
3. Select the Audio menu by pressing “⊙” on the thumbstick.
4. Digital Output will be automatically highlighted.
5. Move the highlight to the right with “▶” on the thumbstick .
6. Select one of the three options and press “⊙” to return to the previous level.
7. Press the **Exit** button on the remote control to return to TV viewing.



8. CUSTOMIZATION

8-10. Setting the Audio

PCM(Digital)

Pulse Code Modulation (PCM) decoders support L/R stereo only. If selected, audio outputs are decoded and transmitted in PCM mode.

Dolby Digital

Dolby Digital, also known as AC-3 for Audio Coding 3rd Generation or “5.1” channel audio, is a coding technique that provides five independent, full frequency response audio channels and one low frequency bass channel.

NOTE

Refer to section 2.4 to see more detailed information.



8-10. Setting the Audio

Audio Mode

Lets you choose the default audio mode when a program is broadcasting in analog format. When you view a program broadcast in mono, you will hear only mono sound, even though Stereo mode is set. When Second Audio Program "SAP" mode is set, the program's second audio program is broadcast in mono, if provided.

To Set the Analog Audio Mode:

1. Press the **Menu** button on the Remote Control to display the screen menu.
2. Scroll down by using "**▲▼**" on the thumbstick on the remote control.
3. Select the Audio menu by pressing "**⊙**" on the thumbstick.
4. Scroll down to Audio Mode by using "**▲▼**" on the thumbstick.
5. Move the highlight to the right with "**▶**" on the thumbstick.
6. Select one of the three options and press "**⊙**" to return to the previous level.
7. Press the **Exit** button on the remote control to return to TV viewing.



8. CUSTOMIZATION

8-10. Setting the Audio

Audio Language

Allows you to hear a program in other languages if the program is broadcast in digital format. You may select a language while you are viewing a program by selecting an option of the audio language box in the channel banner and pressing "▲▼" repeatedly to select the desired language.

To set the digital audio language:

1. Press the **Menu** button on the Remote Control to display the on-screen menu.
2. Scroll down by using "▲▼" on the thumbstick on the remote control.
3. Select the Audio menu by pressing "⊙" on the thumbstick.
4. Scroll down to Audio Language by using "▲▼" on the thumbstick.
5. Move the highlight to the right with "▶" on the thumbstick.
6. Select one of the eight language options and press "⊙" to return to the previous level.
7. Press the **Exit** button on the remote control to return to TV viewing.



8-10. Setting the Audio

Variable Audio

Allows you to control the volume with the remote control of the Zenith HD Satellite Receiver.

To set Variable Audio:

1. Press the **Menu** button on the Remote Control to display the on-screen menu.
2. Scroll down by using “▲▼” on the thumbstick on the remote control.
3. Select the Audio menu by pressing “⊙” on the thumbstick.
4. Scroll down to Audio Variable by using “▲▼” on the thumbstick.
5. Move the highlight to the right with “▶” on the thumbstick.
6. Select “On” or “Off” and press “⊙” to return to the previous level.
7. Press the **Exit** button on the remote control to return to TV viewing.



8. CUSTOMIZATION

8-11. Choosing the Aspect Ratio

When you view a picture with a wide (16:9) aspect ratio with 480i or 480p mode of display format switch in the rear panel, the button changes the screen format in the cycle of Letterbox, Cropped, to Squeezed. When you view a picture with a normal (4:3) aspect ratio on a with 720p or 1080i mode of display format switch, the button changes the screen format in the cycle of Normal, Wide, Panorama, Zoom1, to Zoom2.

Choosing the screen format of your TV:

1. Press the **Menu** button on the Remote Control to display the on-screen menu.
2. Scroll down by using “▲▼” on the thumbstick on the remote control.
3. Select the Preference menu by pressing “⊙” on the thumbstick.
4. TV Aspect Ratio will be automatically highlighted.
5. Move the highlight to the right with “▶” on the thumbstick.
6. Select one of the options and press “⊙” to return to the previous level.
7. Press the **Exit** button on the remote control to return to TV viewing.



8-11. Choosing the Aspect Ratio

Modes for viewing wide IMAGE (16:9) on a normal TV (4:3) DISPLAY
FORMAT SWITCH IN 480i OR 480p POSITION.:

Letter Box

Use for a picture with an original 16:9 aspect ratio (in a wide format). Letterbox mode will shrink the picture to fill the screen, with black (or blank) bars appearing at the top and bottom of the screen.

Cropped

Use for a picture filling the entire screen by cropping (removing) the left and right portions of the picture.

Squeezed

Use for a full picture filling the entire screen with no black bars. The picture in a 16:9 format will be horizontally adjusted or squeezed to fit the 4:3 ratio monitor.

Modes for viewing normal IMAGE (4:3) on a wide TV(16:9) DISPLAY
FORMAT SWITCH IN 720p OR 1080i POSITION.:

Normal

Use for a picture with an original 4:3 aspect ratio on your 16:9 monitor, with black bars appearing at the left and right sides.

Wide

Use for a picture adjusted horizontally (in a linear proportion) to fill the entire screen. You may find this setting useful for viewing 4:3 formatted DVDs.

Panorama

Use to adjust a picture in a non-linear proportion (more at both sides) to create a spectacle view.

Zoom1

Use when you want to fill the entire screen with no black bars appearing. The image will be altered both horizontally (stretched) and vertically (cropped). The top and bottom portions of the picture will be cut.

Zoom2

Use to view the picture without distortion. Note that the top and bottom portions of the picture will be cropped (removed).

8. CUSTOMIZATION

8-12. Setting Closed Caption

Lets you select a mode for displaying Closed Caption displays information, usually the program's dialog, at any position on the screen. Text displays information, usually at the bottom position, and is used for a data service.

To set Closed Caption:

1. Press the **Menu** button on the Remote Control to display the screen menu.
2. Scroll down by using "▲▼" on the thumbstick on the remote control.
3. Select the Preference menu by pressing "⊙" on the thumbstick.
4. Scroll down to Closed Caption by using "▲▼" on the thumbstick.
5. Move the highlight to the right with "▶" on the thumbstick.
6. Select one of the options and press "⊙" to return to the previous level.
7. Press the **Exit** button on the remote control to return to TV viewing.



8-12. Setting Closed Caption

Caption1 (CC1)

CC1 is the primary caption service that synchronizes the captioning language with the sound, used by most broadcasters. The captioning is displayed in the same language as the program's dialog.

Caption2 (CC2)

CC2 is the special non-synchronous caption service that does not need to be in sync with the sound and may provide simplified captioning, which is usually delayed. CC2 is rarely available and broadcasters use them only in special circumstances, such as when CC1 and CC3 are not available.

Caption3 (CC3)

CC3 serves as an alternate captioning service channel. The captioning is often a secondary language translation such as French, Spanish, simplified English or displayed at a slower rate.

Caption4 (CC4)

CC4 is another special non-synchronous caption service that does not need to be in sync with the sound and may provide simplified captioning, usually delayed. CC4 is rarely available and broadcasters use CC4 only in special circumstances, such as when CC1 and CC3 are not available.

Text1

Text1 is the primary text service used by broadcasters. Text1 usually displays information at the bottom position and is used for a data service, generally not program related.

Text2

Text2 is the second text service used by broadcasters and is rarely available. Broadcasters use Text2 only in special circumstances, such as when Text1 is not available.

Text3

Text3 is the third text service used by broadcasters and is rarely available. Broadcasters use Text3 only in special circumstances, such as when Text1 is not available.

Text4

Text4 is the fourth text service used by broadcasters and is rarely available. Broadcasters use Text4 only in special circumstances, such as when Text1 is not available.

8. CUSTOMIZATION

8-13. Setting Default Signal Out

Output Channel

Lets you choose the channel used to view your Zenith HD Satellite Receiver, either channel 3 or, 4. Make sure your TV is set to the selected channel.

To set the channel number of the HD satellite receiver:

1. Press the **Menu** button on the Remote Control to display the on-screen menu.
2. Scroll down by using "▲▼" on the thumbstick on the remote control.
3. Select the Preference menu by pressing "⊙" on the thumbstick.
4. Scroll down to Output Channel by using "▲▼" on the thumbstick.
5. Move the highlight to the right with "▶" on the thumbstick.
6. Select Channel 3 or 4 and press "⊙" to return to the previous level.
7. Press the **Exit** button on the remote control to return to TV viewing.



8-13. Setting Default Signal Out

Out to TV -- Default Connection

Lets you choose whether the OUT TO TV jack is connected to either the CABLE IN or ANT IN jack in standby mode.

To set the standby mode default signal source:

1. Press the **Menu** button on the Remote Control to display the on-screen menu.
2. Scroll down by using "▲▼" on the thumbstick on the remote control.
3. Select the Preference menu by pressing "⊙" on the thumbstick.
4. Scroll down to Out to TV by using "▲▼" on the thumbstick.
5. Move the highlight to the right with "▶" on the thumbstick.
6. Select Antenna or Cable and press "⊙" to return to the previous level.
7. Press the **Exit** button on the remote control to return to TV viewing.



8. CUSTOMIZATION

8-14. Setting the Digital TV Input

Digital TV Input

Your Zenith HD Satellite Receiver is also capable of receiving a 8-VSB signal, if any, via digital cable. Before you move the highlight in the sub menu, The dialogue box will pop up to make sure if you want to change the mode. After changing it, you should run "EZ Channel Scan" to view a program sent via the designated input.

To set the standby mode as a default signal source:

1. Press the **Menu** button on the Remote Control to display the screen menu.
2. Scroll down by using "▲▼" on the thumbstick on the remote control.
3. Select the Preference menu by pressing "⊙" on the thumbstick.
4. Scroll down to Digital Input by using "▲▼" on the thumbstick.
5. Move the highlight to the right with "▶" on the thumbstick.
6. The pop-up dialogue box will appear when you move the highlight to change the mode.
7. Choose "OK " if you want to change the mode, Otherwise, choose "Cancel".
8. Press the **Exit** button on the remote control to return to TV viewing.



8-15. Running EZ Demo

Shows you how to navigate through the on-screen menus of your Zenith HD Satellite Receiver.

To run EZ Demo:

1. Press the **Menu** button on the Remote Control to display the on-screen menu.
2. Scroll down by using “▲▼” on the thumbstick on the remote control.
3. Select the Preference menu by pressing “⊙” on the thumbstick.
4. Scroll down to EZ Demo by using “▲▼” on the thumbstick.
5. Press “▶” on the thumbstick to display the EZ Demo screen.
The screen will run automatically.
6. Press “◀” anytime to return to the previous screen or press the **Exit** button on the remote control to return to TV viewing.



8. CUSTOMIZATION

8-16. Setting Locks

Lock System

Lets you set up specific channels, ratings and spending limits through blocking schemes. Activates or disables all of the lock schemes previously set up. A password is required to gain access to this menu if the lock system is activated. You can change the password by inputting a new password twice.

To activate or deactivate the Lock System:

1. Press the **Menu** button on the Remote Control to display the on-screen menu.
2. Scroll down by using “▲▼” on the thumbstick on the remote control.
3. Select the Lock menu by pressing “⊙” on the thumbstick.
4. If unlocked, Lock System will be automatically highlighted, otherwise requires a password.

To lock the system :

1. Move the highlight to the right with “▶” on the thumbstick in Lock On/Off box.
2. Switch On or Off by using “▶” Whenever you switch the lock system on or off, you need to enter the password as a reminder.

To set the password:

1. Move the highlight to the right to Set Password with “▶” on the thumbstick.
 2. Enter the password by using the digit buttons on the remote control.
 3. Enter the password again to verify the number.
5. Press “◀” to return to the previous screen or press the **Exit** button on the remote control to return to TV viewing.



NOTE

Once you enter the password on the blocked channel, it will be effective until the HD satellite receiver is off.

8-16. Setting Locks

Block Channel

Blocks any channels that you do not want to view or that you do not want your kids to watch. If you tune in a blocked channel, a black screen with a pop-up screen will appear. You will have to enter the correct password to view the channel. Once you turn off your HD satellite receiver, Block Channel will automatically be reactivated.

To block channels:

1. Press the **Menu** button on the Remote Control to display the on-screen menu.
2. Scroll down by using "▲▼" on the thumbstick on the remote control.
3. Select the Lock menu by pressing "⊙" on the thumbstick.
4. Scroll down to Block Channel by using "▲▼" on the thumbstick.
5. Press "▶" on the thumbstick to display the Block Channel screen.
6. Use "▲▼◀▶" to move the highlight in the channel editing screen.
7. Toggle Blocked or Unblocked by using "⊙" on the thumbstick.
The screen shown at the top left will indicate if the highlighted channel is blocked or unblocked.
8. Press "◀" to return to the previous screen or press the **Exit** button on the remote control to return to TV viewing.



NOTE

When you tune to the blocked channel, the password is required for access.

8. CUSTOMIZATION

8-16. Setting Locks

Movie Rating

Blocks movies according to the movie ratings limit so children cannot view certain movies. You can set the ratings limit by blocking out all the movies with the ratings above a specified level. Keep in mind that the movie ratings limit applies only to movies shown on TV, not TV programs such as soap operas.

To block movie programs:

1. Press the **Menu** button on the Remote Control to display the on-screen menu.
2. Scroll down by using “▲▼” on the thumbstick on the remote control.
3. Select the Lock menu by pressing “⊙” on the thumbstick.
4. Scroll down to Movie Rating by using “▲▼” on the thumbstick.
5. Select the level you want by using “▲▼” and press “⊙” to return to the previous level.
6. Press the **Exit** button on the remote control to return to TV viewing.



NOTE

G: General Audiences

All ages admitted.

PG: Parental Guidance Suggestion.

Some material may not be suitable for children.

PG-13: Parents Strongly Cautioned

Some material may not be appropriate for children under 13.

R: Restricted Under 17 requires accompanying parent or adult guardian.

NC-17: No one 17 and under admitted.

8-16. Setting Locks

TV Rating for Children's Programs

Keeps children from watching certain children's TV programs according to the ratings limit. This rating applies only to TV programs for children. Unless you block TV programs intended for mature audiences in the TV Rating – General menu, your children may view those programs.

To block TV programs:

1. Press the **Menu** button on the Remote Control to display the on-screen menu.
2. Scroll down by using “▲▼” on the thumbstick on the remote control.
3. Select the Lock menu by pressing “⊙” on the thumbstick.
4. Scroll down to TV Rating-Children by using “▲▼” on the thumbstick.
5. Select Age or Content, if you want to lock a TV program based on age or content.
6. Select the level you want by using “▲▼” and press “⊙” to return to the previous level.
7. Press the **Exit** button on the remote control to return to TV viewing.



NOTE

TV-Y: All Children.

This program is designed to be appropriate for all children.

TV-Y7: Directed to Older Children.

This program is designed for children age 7 and above.

TV-G: General Audience.

Most parents would find this program suitable for all ages.

TV-PG: Parental Guidance Suggested.

This program contains material that parents may find unsuitable for younger children.

TV-14: Parents Strongly Cautioned.

This program contains some material that many parents would find unsuitable for children under 14 years of age.

TV-MA: Mature Audience Only.

This program is specifically designed to be viewed by adults and therefore may be unsuitable for children under 17.

8. CUSTOMIZATION

8-16. Setting Locks

TV Rating for General Programs

Blocks TV programs that you and your family do not wish to watch, based on the rating scheme.

To block TV programs:

1. Press the **Menu** button on the Remote Control to display the on-screen menu.
2. Scroll down by using “▲▼” on the thumbstick on the remote control.
3. Select the Lock menu by pressing “⊙” on the thumbstick.
4. Scroll down to TV Rating-General by using “▲▼” on the thumbstick.
5. Select Age or Content, if you want to lock a TV program based on age or content.
6. Select the level you want by using “▲▼” and press “⊙” to return to the previous level.
7. Press the **Exit** button on the remote control to return to TV viewing.



NOTE

TV-Y: All Children.

This program is designed to be appropriate for all children.

TV-Y7: Directed to Older Children.

This program is designed for children age 7 and above.

TV-G: General Audience.

Most parents would find this program suitable for all ages.

TV-PG: Parental Guidance Suggested.

This program contains material that parents may find unsuitable for younger children.

TV-14: Parents Strongly Cautioned.

This program contains some material that many parents would find unsuitable for children under 14 years of age.

TV-MA: Mature Audience Only.

This program is specifically designed to be viewed by adults and therefore may be unsuitable for children under 17.

8-16. Setting Locks

Spending Limit

Sets the spending limit of each PPV program. After a spending limit is set and the system is locked, you must enter the password to purchase a PPV program that costs more than your spending limit allows. The system will temporarily unlock the limit you previously set. Once the receiver is turned off and then turned back on, the lock will be reactivated.

To set the spending limit of each PPV program:

1. Press the **Menu** button on the Remote Control to display the on-screen menu.
2. Scroll down by using "▲▼" on the thumbstick on the remote control.
3. Select the Lock menu by pressing "⊙" on the thumbstick.
4. Scroll down to Spending Limit by using "▲▼" on the thumbstick.
5. Move the highlight to the right with "▶" on the thumbstick in the entry box.
6. Enter the maximum amount of money to be spent on each PPV program.
7. Press "⊙" to return to the previous level.
8. Press the **Exit** button on the remote control to return to TV viewing.



8. CUSTOMIZATION

8-17. Testing the System

Checks the integrity of the DIRECTV System. If any problems are detected, a short message will be displayed.

To test the HD satellite receiver :

1. Press the **Menu** button on the Remote Control to display the on-screen menu.
2. Scroll down by using “▲▼” on the thumbstick on the remote control.
3. Select the System menu by pressing “⊙” on the thumbstick.
4. System Test will be automatically highlighted.
5. Move the highlight to the right with “▶” on the thumbstick to the Start button.
6. Press “⊙” to activate the system test.

It will run automatically from Signal Strength to Phone Connection and if there is any problem in your system, the pop-up box will be displayed.

The highlight will return to the previous level after the process is finished.

7. Press the **Exit** button on the remote control to return to TV viewing.



8-18. Upgrading Software

Shows you the current software version. If DIRECTV plans to upgrade its software, you will be notified by a pop-up box on your TV screen and the pop-up box will ask you if you want to upgrade your system.

To upgrade the software in your Zenith HD Satellite Receiver:

1. Press the **Menu** button on the Remote Control to display the on-screen menu.
2. Scroll down by using "▲▼" on the thumbstick on the remote control.
3. Select the System menu by pressing "⊙" on the thumbstick.
4. Scroll down to S/W Upgrade by using "▲▼" on the thumbstick.
5. You can see the current software version on the right side of the menu.

The next version will be seen if DIRECTV plans to upgrade the software.

6. Press the **Exit** button on the remote control to return to TV viewing.

Your digital satellite receiver is able to receive upgrades or modifications to some of its features and functions. These modifications will automatically be finished, usually at times when the receiver would likely be turned off. If your receiver is on when an upgrade or modification is sent, you may experience a disruption in reception for a minute or two. Your reception should return to normal after the modification is complete. Your receiver must be plugged in to receive any upgrades. Do not unplug your receiver while an upgrade is in progress. Please consult the Upgrade Menu to find a schedule of upgrades or modifications planned by DIRECTV.



8. CUSTOMIZATION

8-19. Replace Card

DIRECTV may issue you a replacement access card periodically, if you are a DIRECTV customer. This menu enables you to transfer information, such as the record of your purchases, from the old card onto a new one. The access card fits into the slot on the back panel of your HD Satellite Receiver.



Once you proceed past "Read Old Card", replace card cannot be cancelled.

To replace the card :

1. Press the **Menu** button on the Remote Control to display the on-screen menu.
2. Scroll down by using "▲▼" on the thumbstick on the remote control.
3. Select the System menu by pressing "⊙" on the thumbstick.
4. Scroll down to Replace Card by using "▲▼" on the thumbstick.
5. Move the highlight to the right with "▶" on the thumbstick to the Read the Old Card button.
6. Press "⊙" to activate the Replace Card.

The pop-up box will be displayed. If you want the process to proceed, follow the instructions in the pop-up box.

The highlight will return to the previous level after the process is finished.

7. Press the **Exit** button on the remote control to return to TV viewing.



9. EZ HELP

9-1. EZ Help

The EZ Help feature is designed to let you understand each function of the Menu and Advanced Program in an easy and convenient way. When you navigate through the Menu and Advanced Program Guide™, press and hold the **"Help (?)"** button on your remote control if you want information about the highlighted item. The information will be displayed on the right side of the TV screen.

Simply press and hold to see the helpful information.

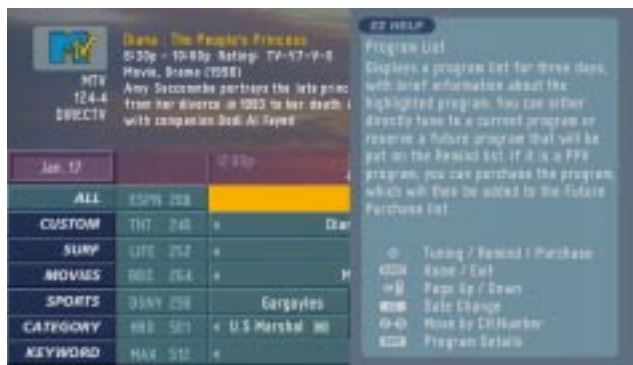

NOTE

Pressing the **"Help (?)"** button independently will activate the EZ Help feature. However, when the MENU or the Advanced Program Guide™ is already displayed, pressing the **"Help (?)"** button will also activate the EZ Help feature.

9. EZ HELP

9-1. EZ Help

The EZ Help is an on-line version of this Operating Guide. You can review the major user interface features of the HD satellite receiver by navigating through a simple structure. It contains a brief overview of the Zenith HD Satellite Receiver, the use and programming of the remote control, a functional explanation of the front and back panel, and an instructive note about the Menu and the Advanced Program Guide™.

The see the EZ Help feature:

1. Press the **"Help (?)"** button on the remote control to display the EZ Help screen.
2. Scroll up and down to select EZ Help menu items by using **"▲▼"** on the thumbstick of the remote control.
3. Move the highlight by using **"▲▼◀▶"** on the thumbstick.
The explanations of the highlighted item will be displayed on the right side or at the bottom of the screen.
4. Press the **Exit** button on the remote control if you want to return to TV viewing.



Remote Control/Programming Remote



Front & Back panel

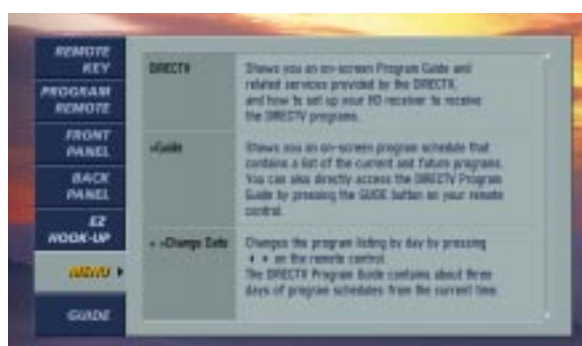

Menu and Program Guide™

PRODUCT SPECIFICATIONS

Specification For ZENITH HD Satellite Receiver

Model Number : Zenith DTV1080

INPUT FORMATS (ATSC compliant)	
1280 x 720	16:9 : 60P,30P,24P,23.976P,29.97P,59.94P
1920 x 1080	16:9 : 60I,30P,24P,23.976P,29.97P,59.94I
640 x 480	4:3 : 60I,30P,24P,23.976P,29.97P,59.94P,60P,59.94I
704 x 480 59.94I	4:3/16:9 : 60I,30P,24P,23.976P,29.97P,59.94P,60P,59.94I
Transport	MPEG2, ISO/IEC 13818 - 1 per ATSC spec A/53
Video decoder ISO/IEC 13818 - 2	MPEG2: <u>MP@HL</u> , <u>MP@ML</u>
Tuning System Capabilities	NTSC : 52-806 MHz ATSC : 52-806 MHz, 8-VSB/DIGITAL/Terrestrial over 6 Mhz channels DIRECTV : 950-1450 MHz
INPUTS	
ATSC/NTSC RF	Antenna (1), Cable (1), Loop out (1)
DIRECTV RF	DBS RF Antenna in
Smart Card	Slot on the back
OUTPUTS	
Dolby Digital	Coax cable (1), Optical Output (1)
A/V output	A/V (525/480i)(2)
RGB Out	15-Pin connector (1)
Component Video Out Y,PB,PR	1080i, 720p, 480p (1)
S-Video Out	
Calibration Port	Serial Port (1)
VIDEO FEATURES	
MPEG2 per ISO/IEC-13818-2	
DIRECTV SD MPEG	
DIRECTV HD MPEG	
Aspect Ratio Mode (16:9)	Normal, Wide, Panorama, Zoom1, Zoom2
Aspect Ratio Mode (4:3)	Letterbox, Crop, Squeeze
Variable bit rate decoding	
Built in format/scan converter	
SYSTEM/CUSTOM INTERFACE FEATURE	
OSD/MENU APG System	
Manual Keyboard	8 Key
Remote Control w/thumbstick	
Power ON/STBY LED	GREEN/RED
RF Remod	Channel 3/4
STBY Loop-out	Antenna/Cable

PRODUCT SPECIFICATIONS

AUDIO FEATURES	
Dolby Digital (AC-3)	
Linear PCM Audio	20bit
Analog output level	200mV RMS, 1 RCA color-coded jack
Analog output level (Maximum)	3.0V RMS
Frequency Response (+/- 1dB)	20-20kHz
Digital outputs	Optical, Coaxial
Analog outputs	2 RCA (phono type)/color-coded jacks
GENERAL	
Power Consumption	100Watts Max / 120VAC
Standby Power 100	<20 Watts/120VAC (17Watts typ)
Power line	90 VAC to 137 VAC
Weight	
Environment	Operation Temperature: 0 to 40 degrees Celsius
Humidity: 0 to 99 percent non condensing	
Storage : 10 to + 50 degree Celsius	
Safety and Regulation	Dolby Digital
UL: Complies with UL 1492 and NOM	
FCC: Complies with FCC Class "B"	
Mechanical Dimensions	3.82 inches (H), 16.99 inches (W), 11.81 inches (D)/97H x 431.6W x 300D
AC Line connector/cable	3pin/6.0 feet

TROUBLESHOOTING

Zenith and DIRECTV are dedicated to providing you with quality support and customer service. If you have questions or difficulties that you cannot resolve using the tips in this troubleshooting section, consult your dealer or call DIRECTV at Digital TV Hotline(1-877-939-6484) for regarding to broadcasting and Zenith Customer Support at 1-800-DIRECTV(1-800-347-3288) for regarding to your STB.

SYMPTOMS	SOLUTIONS
No power.	- Is the AC power plugged in?
Snowy picture and unclear sound.	<ul style="list-style-type: none"> - Check your antenna input or location. - Check your cable input. - Check your satellite input.
No picture.	<ul style="list-style-type: none"> - Make sure that the right display format is selected. If Zenith HD Satellite Receiver is connected to your monitor or TV via ports of "A/V OUT" on the back panel, the "DISPLAY FORMAT" switch on the back panel must be 480i. Otherwise, you may not be able to see a picture. - Make sure that the right component type is selected. If Zenith HD Receiver is connected to your monitor or TV via RGB port on the back panel, the "COMPONENT TYPE" switch must be flipped to the right. Otherwise, you may not be able to see a picture. - Due to copyright restrictions, you may not be able to view some high definition programs in high definition format. - For more information about connections, please refer to section 3 of this manual.
Normal picture but no sound.	<ul style="list-style-type: none"> - Check volume levels. - Make sure the TV is not muted. - Make sure the Zenith HD Receiver is not muted. - Check that the Zenith HD receiver is connected properly.
Picture is distorted.	<ul style="list-style-type: none"> - Make sure the proper display format is selected. - Make sure the proper aspect ratio is selected. - Make sure the video output is connected to the TV.
Available channels are missing.	<ul style="list-style-type: none"> - If you are a DIRECTV customer, you can add a channel by running the "Manual Ch. Add" from the SETUP menu or finds all available channels by running the "EZ Channel Scan" of the SETUP menu. - Otherwise, if the Zenith HD Receiver is in the ANT/CABLE mode, you can only find all available channels by running the "EZ Channel Scan" of the SETUP menu.

TROUBLESHOOTING

SYMPTOMS	SOLUTIONS
A 4:3 Aspect ratio cannot be selected.	- Aspect ratio depends on both the incoming program format and the display format switch on the back panel. Once the switch for the display format is set to a standard definition (480I/480P) and the incoming program is set at a 4:3 video, it is not be available for selection and a warning message will appear on the screen.
A 16:9 Aspect ratio cannot be selected.	- Similar to the above case, once the switch for a display format is set to a high definition (720P/1080I) and an incoming program is set at a 16:9 video, it will not be available for selection and a warning message will appear on the screen.
The remote control is not respinding.	- Make sure the batteries are fresh and installed properly. - Point the remote control unit at the remote control sensor. - Check if a mode on the remote control is selected properly.
The timer does not work.	- Make sure the clock is set properly.
You forget your password.	- If you are a DIRECTV customer, make a call at DIRECTV Service Center and ask them to clear your password. - Otherwise, if the Zenith HD Receiver is in the ANT/CABLE mode, enter master key number "7777" when it asks you to enter the password.

ZENITH ELECTRONICS CORPORATION HD SATELLITE RECEIVER LIMITED WARRANTY-USA

Zenith, will repair or replace your product, at Zenith's option, if it proves to be defective in material or workmanship under normal use, during the warranty period listed below from the date of original consumer purchase. This warranty is available only to the original purchaser of the product and effective only when used in the United States, excluding U.S. Territories.

<p>ONE YEAR WARRANTY PERIOD:</p> <p>0 to 90 days: Your unit will be repaired or replaced with a new, substitute model or factory reconditioned unit. If repaired, parts may be new or remanufactured.</p> <p>91 to 365 days: Your unit will be repaired or replaced with a new, substitute model or factory reconditioned unit. Zenith may add a fee for labor charges. If repaired, parts may be new or remanufactured.</p> <p>Repair Parts and Replacement Units are warranted for the remaining period of the original warranty.</p>	<p>HOW SERVICE IS HANDLED:</p> <p>If replacement unit is available and to get the unit in 2 working days, Zenith requires a reserved deposit by credit card as surety for advance shipment. Your credit card will not be charged if you returned the defective unit in 10 working days. For further instructions please see below.</p> <p>Please retain your box to return the unit to Zenith.</p> <p>Shipping charges both ways for claims within the first 90 days will be paid by Zenith; after 90 days during the warranty period, you pay in-bound shipping charges and Zenith pays return shipping charges.</p>
---	--

THIS WARRANTY IS IN LIEU OF ANY OTHER WARRANTY, EXPRESS OR IMPLIED, INCLUDING WITHOUT LIMITATION, ANY WARRANTY OF MERCHANTABILITY OR FITNESS FOR A PARTICULAR PURPOSE. TO THE EXTENT ANY IMPLIED WARRANTY IS REQUIRED BY LAW, IT IS LIMITED IN DURATION TO THE EXPRESS WARRANTY PERIOD ABOVE. ZENITH WILL NOT BE LIABLE FOR ANY INCIDENTAL, CONSEQUENTIAL, INDIRECT, OR SPECIAL DAMAGES OF ANY NATURE, INCLUDING WITHOUT LIMITATION LOST PROFITS PROGRAMMING OR DATA, OR ANY OTHER DAMAGE WHETHER BASED IN CONTRACT, TORT OR OTHERWISE. Some states do not allow the exclusion or limitation of incidental or consequential damages or limitations on how long an implied warranty lasts, so the above exclusion or limitation may not apply to you. This warranty gives you specific legal rights and you may also have other rights that vary from state to state.

THIS LIMITED WARRANTY DOES NOT APPLY:

- To damages or problems that result from shipping, installation, calibration, maintenance or separate system components.
- To damages or problems that result from misuse, abuse, operation outside environmental specifications or contrary to the requirements and precautions in the Operating Guide, accident, lightning strikes or other natural causes, modification or alteration, incorrect electrical current or voltage, signal reception or input, software errors that do not disable functionality, operating and software protocols adopted after date of manufacture or for outside the U.S., or institutional or commercial use.

Therefore, you pay for the cost of repair or replacement under these circumstances.

CUSTOMER ASSISTANCE NUMBERS:

<p>To prove warranty coverage:</p>	<p>Retain your dated sales receipt to prove date of purchase as well as your box for shipping the unit in to Zenith.</p> <p>Legible copy of your sales receipt must be submitted with the unit at the time warranty service is provided.</p>
<p>To obtain where-to-buy, product assistance customer assistance or Return Authorization:</p>	<p>Call 1-877-9Zenith 1-877-993-6484 (Mon. - Fri. 7AM to 8 PM CT) Sat 8AM to 5PM. Please select the appropriate option from the menu.</p>

FOR SERVICE:

You must call Product Assistance (1-877-984-9349 Mon. - Fri. 7AM to 8PM CT Please select the appropriate option from the menu), to confirm the product is defective and to obtain Return Authorization (RA). If requesting 2-day advance shipment they will ask for your credit card number. During the warranty period, Zenith will send you a return-shipping label. After you obtain authorization for return, please box your unit with a copy of the sales receipt and enough packing material to assure undamaged delivery of your product. When you receive the label, place it on the box and call the 800 # in the instruction for pick-up. When your unit is received, Zenith will repair or replace your unit in accordance with this Limited Warranty. For advance shipment, the return label will come with The replacement sent to you. Please follow boxing and shipping instructions above.

www.zenith.com
(256) 772-1515

P/NO : 3828VA0220B (ND00QA, SH-011S)